

**3 COAT STUCCO**

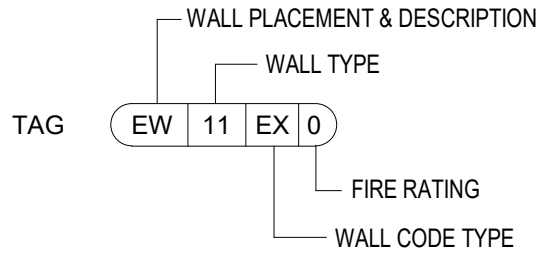

NAME: EW\_F\_11\_0 (3KS\_1GB)  
 COMMENT: EXT WD  
 ASSEMBLY: N/A  
 DESCRIPTION: TYPICAL EXTERIOR WALL NON-RATED

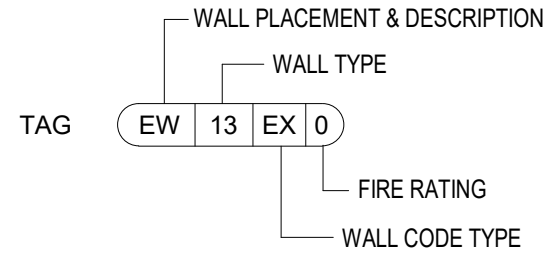

NAME: EW\_F\_13\_0 (3KS\_3KS)  
 COMMENT: EXT WD  
 ASSEMBLY: N/A  
 DESCRIPTION: EXTERIOR WALL WITH STUCCO ON BOTH SIDES NON-RATED

**1 COAT STUCCO**

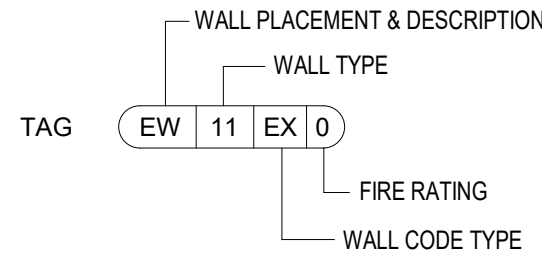

NAME: EW\_F\_11\_0 (1KS\_1GB)  
 COMMENT: EXT WD  
 ASSEMBLY: N/A  
 DESCRIPTION: TYPICAL EXTERIOR WALL NON-RATED

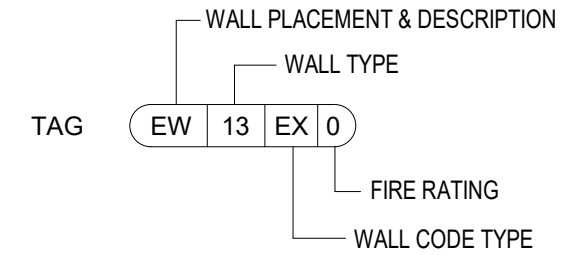

NAME: EW\_F\_13\_0 (1KS\_1KS)  
 COMMENT: EXT WD  
 ASSEMBLY: N/A  
 DESCRIPTION: EXTERIOR WALL WITH STUCCO ON BOTH SIDES NON-RATED

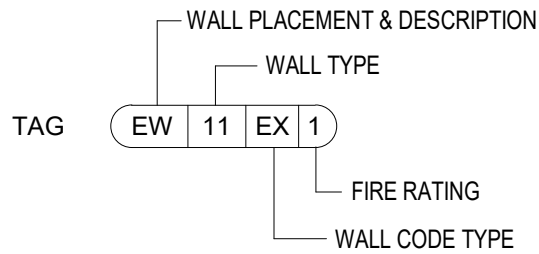

NAME: EW\_F\_11\_1 (3KS\_1GB)  
 COMMENT: EXT WD  
 ASSEMBLY: UL U356  
 DESCRIPTION: TYPICAL EXTERIOR WALL 1-HR RATED

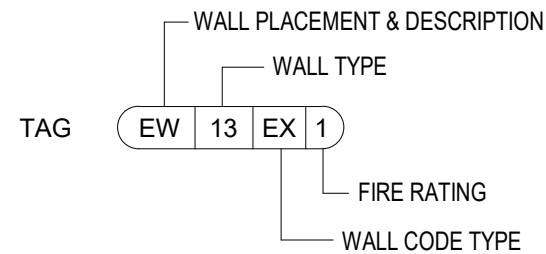

NAME: EW\_F\_13\_1 (3KS\_3KS)  
 COMMENT: EXT WD  
 ASSEMBLY: IBC 721.1 (2)\_ITEM 15-1.2  
 DESCRIPTION: EXTERIOR WALL WITH STUCCO ON BOTH SIDES 1-HR RATED

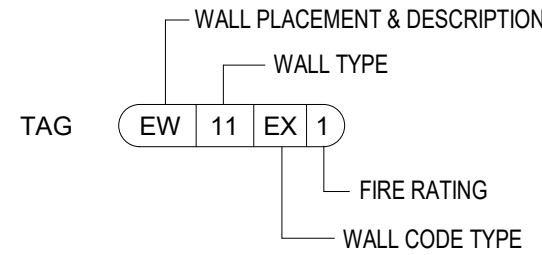

NAME: EW\_F\_11\_1 (1KS\_1GB)  
 COMMENT: EXT WD  
 ASSEMBLY: IBC 721.1(2) ITEM 15-1.3  
 DESCRIPTION: TYPICAL EXTERIOR WALL 1-HR RATED

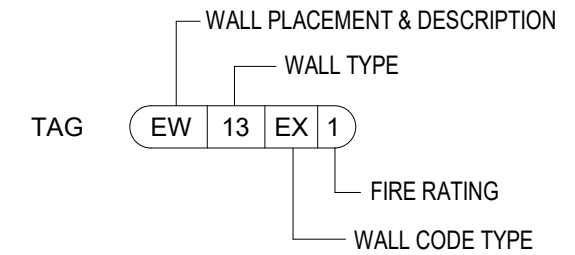

NAME: EW\_F\_13\_1 (1KS\_1KS)  
 COMMENT: EXT WD  
 ASSEMBLY: IBC 721.1 (2)\_ITEM 15-1.2  
 DESCRIPTION: EXTERIOR WALL WITH STUCCO ON BOTH SIDES 1-HR RATED

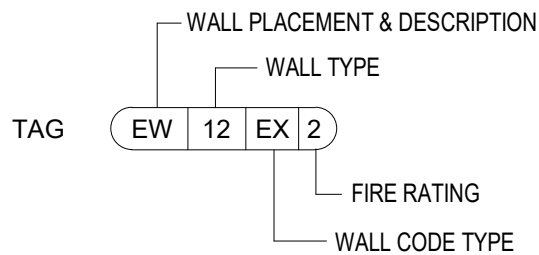

NAME: EW\_F\_12\_2 (3KS\_2GB)  
 COMMENT: EXT WD  
 ASSEMBLY: UL V314  
 DESCRIPTION: TYPICAL EXTERIOR WALL 2-HR RATED

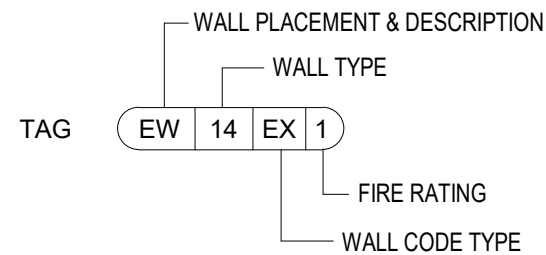

NAME: EW\_F\_14\_1 (3KS\_NA) Unit Separation  
 COMMENT: EXT WD  
 ASSEMBLY: IBC TABLE 721.1(2) ITEM 15-1.2.  
 DESCRIPTION: UNIT SEPARATION WALL WITH STUCCO

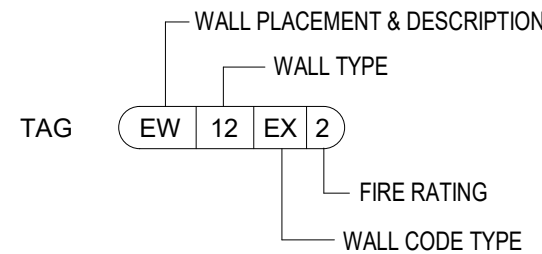

NAME: EW\_F\_12\_2 (1KS\_2GB)  
 COMMENT: EXT WD  
 ASSEMBLY: UL U371  
 DESCRIPTION: TYPICAL EXTERIOR WALL 2-HR RATED

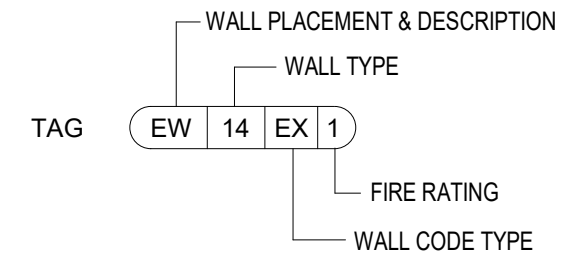

NAME: EW\_F\_14\_1 (1KS\_NA) Unit Separation  
 COMMENT: EXT WD  
 ASSEMBLY: IBC TABLE 721.1(2) ITEM 15-1.2.  
 DESCRIPTION: UNIT SEPARATION WALL WITH STUCCO



**ORB ASSEMBLIES**  
 EXTERIOR WOOD STUD WALLS

**01-EW-F-01**

DATE:  
 04/11/23

### EIFS WOOD STUD

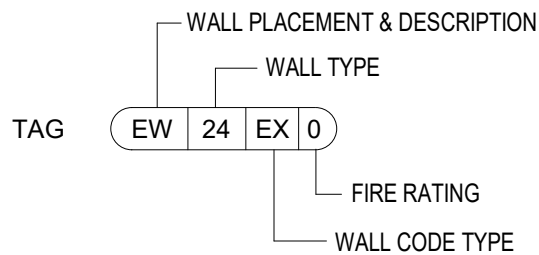

NAME: EW\_F\_24\_0 (EIFS\_2GB)

COMMENT: EXT WD

ASSEMBLY: N/A

DESCRIPTION: EXTERIOR WALL WITH EIFS ON BOTH SIDES NON-RATED

### EIFS WOOD STUD

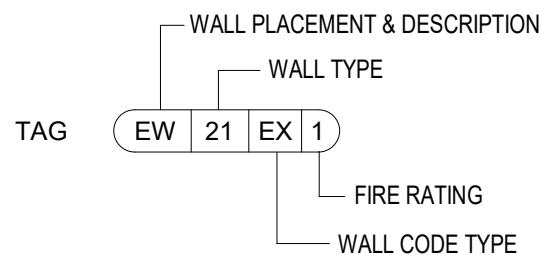

NAME: EW\_F\_21\_1 (EIFS\_1GB)

COMMENT: EXT WD

ASSEMBLY: UL U356

DESCRIPTION: TYPICAL EXTERIOR WALL 1-HR RATED

### GARAGE WRAP - WOOD STUD

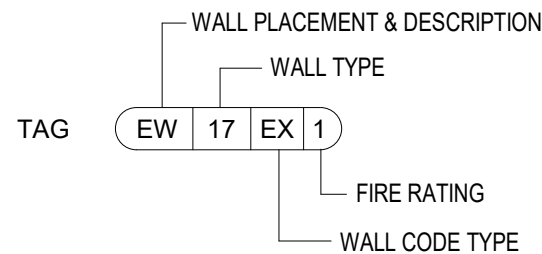

NAME: EW\_17\_1 (4\_1GB)

COMMENT: EXT WD

ASSEMBLY: IBC TABLE 721.1(2) ITEM 16-1.1

DESCRIPTION: GARAGE WRAP EXTERIOR WALL - 1-HR RATED

### 3-COAT STUCCO

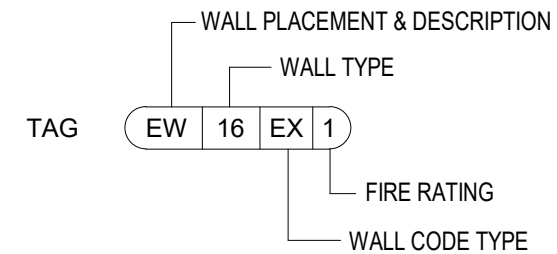

NAME: EW\_F\_16\_1 (3KS\_1GB)

COMMENT: EXT WD

ASSEMBLY: UL U346

DESCRIPTION: TYPICAL EXTERIOR WALL 1-HR RATED FROM BOTH SIDES

### 1-COAT STUCCO

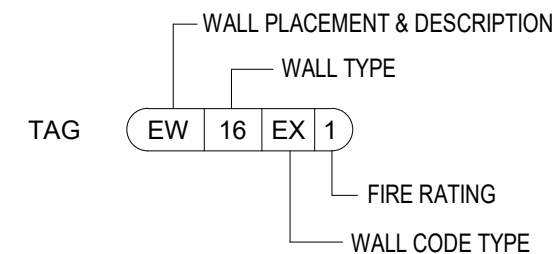

NAME: EW\_F\_16\_1 (1KS\_1GB)

COMMENT: EXT WD

ASSEMBLY: UL U346

DESCRIPTION: TYPICAL EXTERIOR WALL 1-HR RATED FROM BOTH SIDES

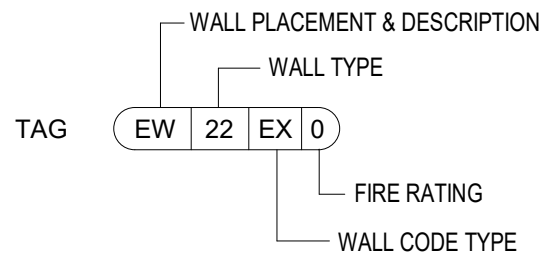

NAME: EW\_F\_22\_0 (EIFS\_1GB)

COMMENT: EXT WD

ASSEMBLY: N/A

DESCRIPTION: EXTERIOR WALL WITH EIFS ON BOTH SIDES NON-RATED

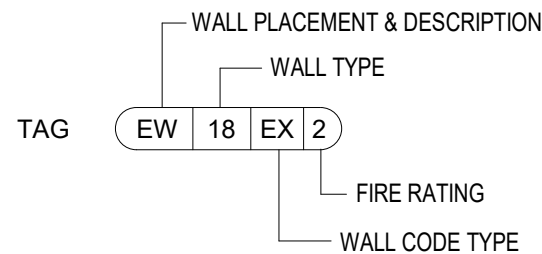

NAME: EW\_18\_2 (4\_2GB)

COMMENT: EXT WD

ASSEMBLY: UL DESIGN NO V314

DESCRIPTION: GARAGE WRAP EXTERIOR WALL - 2-HR RATED

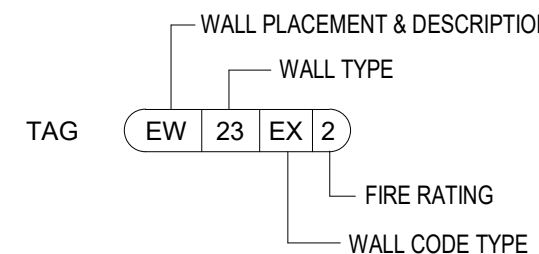

NAME: EW\_F\_23\_2 (EIFS\_2GB)

COMMENT: EXT WD

ASSEMBLY: UL V314

DESCRIPTION: TYPICAL EXTERIOR WALL 2 HOUR RATED



**ORB ASSEMBLIES**

**EXTERIOR WOOD STUD WALLS**

**01-EW-F-02**

DATE:  
04/11/23

2/5/2024 5:14:58 PM  
Autodesk Docs: //00-000\_Revit\_Detail\_Library/4\_ORB\_Assemblies\_Split\_Walls\_2023.rvt

**METAL SIDING**

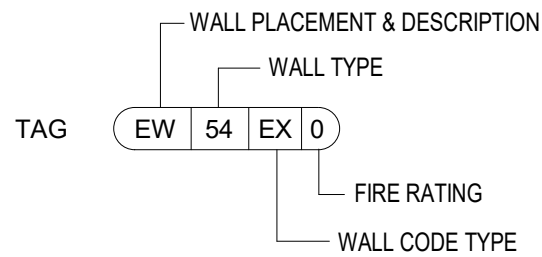

NAME: EW\_F\_54\_0 (Mtl.S\_3KS)  
 COMMENT: VENEER ON EXT WD  
 ASSEMBLY: N/A  
 DESCRIPTION: WALL WITH METAL SIDING VENEER - STUCCO INSIDE

**METAL SIDING**

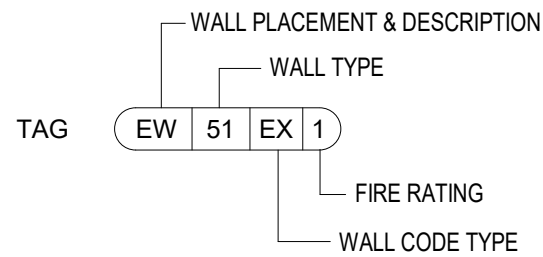

NAME: EW\_F\_51\_1 (Mtl.S\_1GB)  
 COMMENT: VENEER ON EXT WD  
 ASSEMBLY: UL U356  
 DESCRIPTION: WALL WITH METAL SIDING VENEER - GYP INSIDE

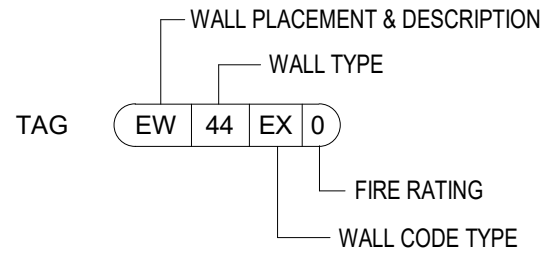

NAME: EW\_F\_44\_0 (CB\_3KS)  
 COMMENT: VENEER ON EXT WD  
 ASSEMBLY: N/A  
 DESCRIPTION: WALL WITH CEMENT BOARD - STUCCO INSIDE

**CEMENT BOARD**

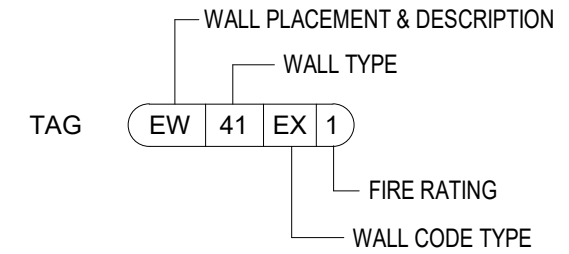

NAME: EW\_F\_41\_1 (CB\_1GB)  
 COMMENT: VENEER ON EXT WD  
 ASSEMBLY: UL U356  
 DESCRIPTION: WALL WITH CEMENT BOARD - GYP INSIDE

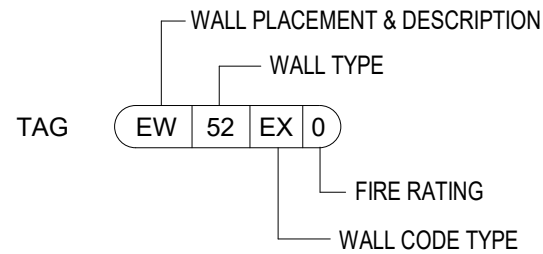

NAME: EW\_F\_52\_0 (Mtl.S\_3KS)  
 COMMENT: VENEER ON EXT WD  
 ASSEMBLY: IBC TABLE 721.1(2) 15-1.3  
 DESCRIPTION: WALL WITH METAL SIDING VENEER - STUCCO INSIDE

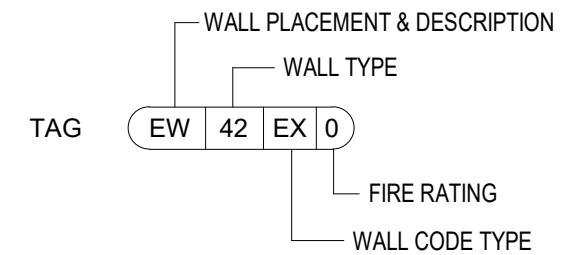

NAME: EW\_F\_42\_0 (CB\_3KS)  
 COMMENT: VENEER ON EXT WD  
 ASSEMBLY: N/A  
 DESCRIPTION: WALL WITH CEMENT BOARD - STUCCO INSIDE

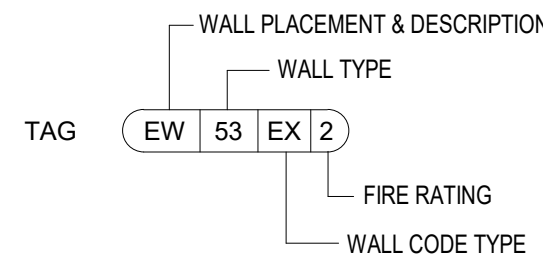

NAME: EW\_F\_53\_2 (Mtl.S\_2GB)  
 COMMENT: VENEER ON EXT WD  
 ASSEMBLY: UL V314  
 DESCRIPTION: WALL WITH METAL SIDING VENEER - (2) GYP INSIDE

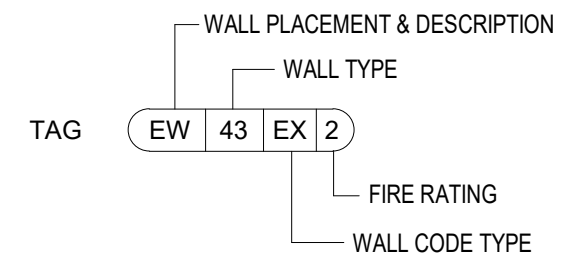

NAME: EW\_F\_43\_2 (CB\_2GB)  
 COMMENT: VENEER ON EXT WD  
 ASSEMBLY: UL V314  
 DESCRIPTION: WALL WITH CEMENT BOARD - (2) GYP INSIDE



**ORB ASSEMBLIES**

**EXTERIOR WOOD STUD WALLS**

**01-EW-F-03**

DATE:  
04/11/23

**CMU VENEER**

WALL PLACEMENT & DESCRIPTION

WALL TYPE

TAG EW 64 EX 0

FIRE RATING

WALL CODE TYPE

NAME: EWV\_F\_64\_0 (UV\_3KS)  
 COMMENT: VENEER ON EXT WD  
 ASSEMBLY: N/A  
 DESCRIPTION: WALL WITH CMU VENEER - STUCCO INSIDE

**CMU VENEER**

WALL PLACEMENT & DESCRIPTION

WALL TYPE

TAG EW 61 EX 1

FIRE RATING

WALL CODE TYPE

NAME: EWV\_F\_61\_1 (UV\_1GB)  
 COMMENT: VENEER ON EXT WD  
 ASSEMBLY: UL U356  
 DESCRIPTION: WALL WITH CMU VENEER - GYP INSIDE

**BRICK VENEER**

WALL PLACEMENT & DESCRIPTION

WALL TYPE

TAG EW 59 EX 0

FIRE RATING

WALL CODE TYPE

NAME: EWV\_F\_59\_0 (BV\_3KS)  
 COMMENT: VENEER ON EXT WD  
 ASSEMBLY: N/A  
 DESCRIPTION: WALL WITH BRICK VENEER - STUCCO INSIDE

**BRICK VENEER**

WALL PLACEMENT & DESCRIPTION

WALL TYPE

TAG EW 56 EX 1

FIRE RATING

WALL CODE TYPE

NAME: EWV\_F\_56\_1 (BV\_1GB)  
 COMMENT: VENEER ON EXT WD  
 ASSEMBLY: UL U356  
 DESCRIPTION: WALL WITH BRICK VENEER - GYP INSIDE

**CMU VENEER**

WALL PLACEMENT & DESCRIPTION

WALL TYPE

TAG EW 63 EX 0

FIRE RATING

WALL CODE TYPE

NAME: EWV\_F\_62\_0 (UV\_3KS)  
 COMMENT: VENEER ON EXT WD  
 ASSEMBLY: N/A  
 DESCRIPTION: WALL WITH CMU VENEER - STUCCO INSIDE

**BRICK VENEER**

WALL PLACEMENT & DESCRIPTION

WALL TYPE

TAG EW 57 EX 0

FIRE RATING

WALL CODE TYPE

NAME: EWV\_F\_57\_0 (BV\_3KS)  
 COMMENT: VENEER ON EXT WD  
 ASSEMBLY: N/A  
 DESCRIPTION: WALL WITH BRICK VENEER - STUCCO INSIDE

**CMU VENEER**

WALL PLACEMENT & DESCRIPTION

WALL TYPE

TAG EW 63 EX 2

FIRE RATING

WALL CODE TYPE

NAME: EWV\_F\_63\_2 (UV\_2GB)  
 COMMENT: VENEER ON EXT WD  
 ASSEMBLY: UL V314  
 DESCRIPTION: WALL WITH CMU VENEER - (2) GYP INSIDE

**BRICK VENEER**

WALL PLACEMENT & DESCRIPTION

WALL TYPE

TAG EW 58 EX 2

FIRE RATING

WALL CODE TYPE

NAME: EWV\_F\_58\_2 (BV\_2GB)  
 COMMENT: VENEER ON EXT WD  
 ASSEMBLY: UL V314  
 DESCRIPTION: WALL WITH BRICK VENEER - (2) GYP INSIDE



**ORB ASSEMBLIES**  
 EXTERIOR WOOD STUD WALLS

**01-EW-F-04**

DATE:  
04/11/23

2/5/2024 5:14:59 PM  
Autodesk Docs: //00-000\_Revit\_Detail\_Library/4\_ORB\_Assemblies\_Split\_Walls\_2023.rvt



**ORB ASSEMBLIES**  
EXTERIOR WOOD STUD WALLS

**STONE VENEER**

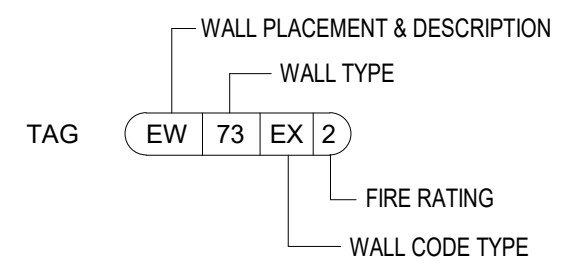

NAME: EWV\_F\_73\_2 (SV\_2GB)  
COMMENT: VENEER ON EXT WD  
ASSEMBLY: UL V314  
DESCRIPTION: WALL WITH STONE VENEER - (2) GYP INSIDE

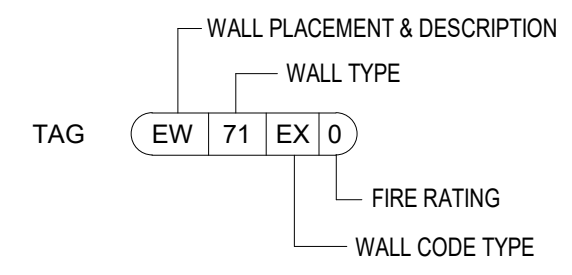

NAME: EWV\_F\_71\_0 (SV\_1GB)  
COMMENT: VENEER ON EXT WD  
ASSEMBLY: -  
DESCRIPTION: WALL WITH STONE VENEER - GYP INSIDE

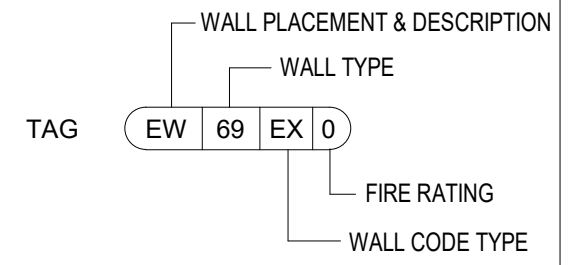

NAME: EWV\_F\_69\_0 (CV\_3KS)  
COMMENT: VENEER ON EXT WD  
ASSEMBLY: N/A  
DESCRIPTION: WALL WITH PRECAST VENEER - STUCCO INSIDE

**PRECAST VENEER**

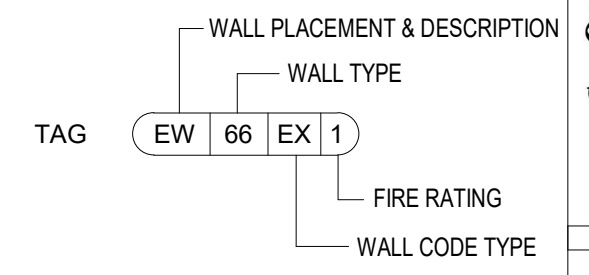

NAME: EWV\_F\_66\_1 (CV\_1GB)  
COMMENT: VENEER ON EXT WD  
ASSEMBLY: UL U356  
DESCRIPTION: WALL WITH PRECAST VENEER - GYP INSIDE

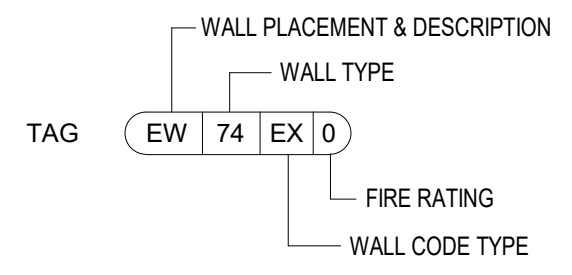

NAME: EWV\_F\_74\_0 (SV\_3KS)  
COMMENT: VENEER ON EXT WD  
ASSEMBLY: N/A  
DESCRIPTION: WALL WITH STONE VENEER - STUCCO INSIDE

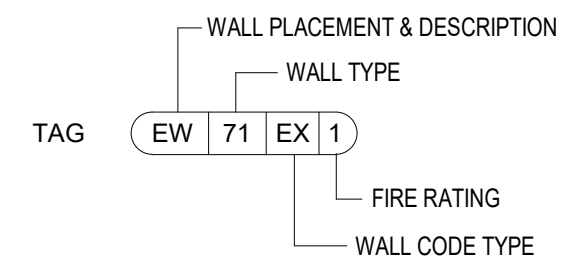

NAME: EWV\_F\_71\_1 (SV\_1GB)  
COMMENT: VENEER ON EXT WD  
ASSEMBLY: UL U356  
DESCRIPTION: WALL WITH STONE VENEER - GYP INSIDE

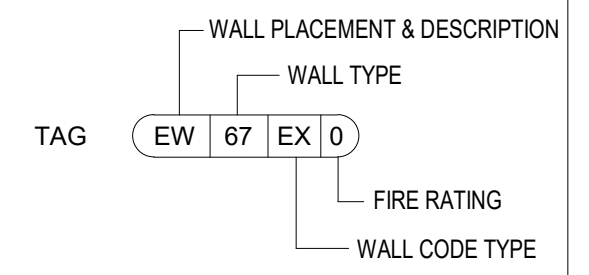

NAME: EWV\_F\_67\_0 (CV\_3KS)  
COMMENT: VENEER ON EXT WD  
ASSEMBLY: N/A  
DESCRIPTION: WALL WITH PRECAST VENEER - STUCCO INSIDE

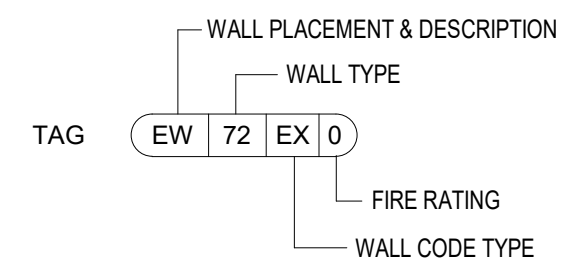

NAME: EWV\_F\_72\_0 (SV\_3KS)  
COMMENT: VENEER ON EXT WD  
ASSEMBLY: N/A  
DESCRIPTION: WALL WITH STONE VENEER - STUCCO INSIDE

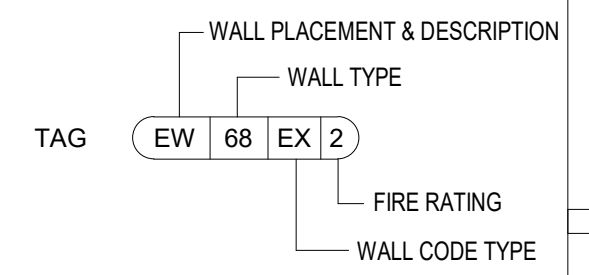

NAME: EWV\_F\_68\_2 (CV\_2GB)  
COMMENT: VENEER ON EXT WD  
ASSEMBLY: UL V314  
DESCRIPTION: WALL WITH PRECAST VENEER - (2) GYP INSIDE

**01-EW-F-05**  
DATE: 04/11/23



**ORB ASSEMBLIES**  
EXTERIOR WOOD STUD WALLS

**01-EW-F-06**

DATE:  
04/11/23

**HARDIE PLANK - LAP SIDING**

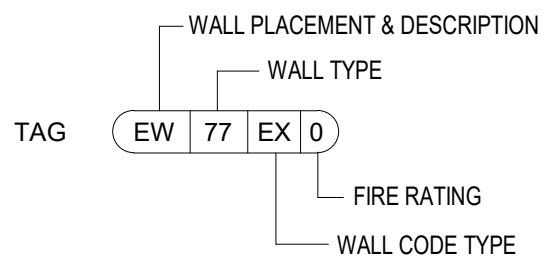

NAME: EWH\_F\_79\_0 (HP\_3KS)  
 COMMENT: HARDIE PLANK ON EXT WD  
 ASSEMBLY: N/A  
 DESCRIPTION: WALL WITH HARDIE PLANK - STUCCO INSIDE

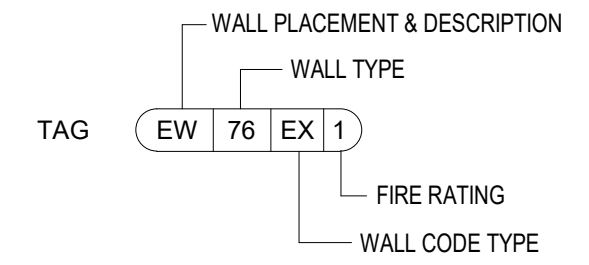

NAME: EWH\_F\_76\_1 (HP\_1GB)  
 COMMENT: HARDIE PLANK ON EXT WD  
 ASSEMBLY: UL U356  
 DESCRIPTION: WALL WITH HARDIE PLANK - GYP INSIDE

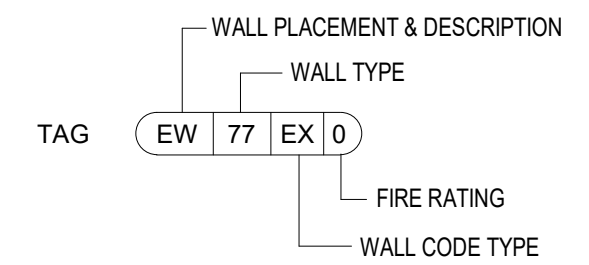

NAME: EWH\_F\_77\_0 (HP\_3KS)  
 COMMENT: HARDIE PLANK ON EXT WD  
 ASSEMBLY: N/A  
 DESCRIPTION: WALL WITH HARDIE PLANK - STUCCO INSIDE

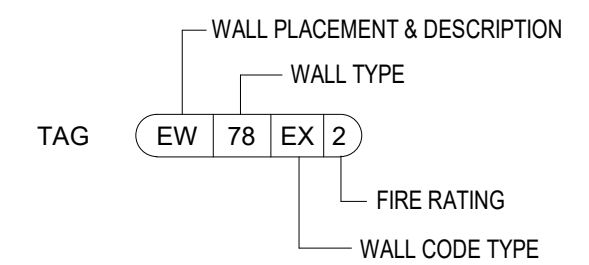

NAME: EWH\_F\_78\_2 (HP\_2GB)  
 COMMENT: HARDIE PLANK ON EXT WD  
 ASSEMBLY: UL V314  
 DESCRIPTION: WALL WITH METAL SIDING VENEER - (2) GYP INSIDE

3 COAT STUCCO

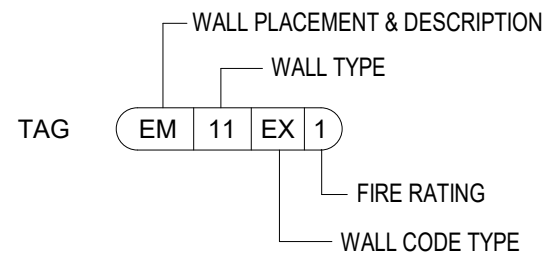

NAME: EM\_F\_11\_1 (3KS\_1GB)

COMMENT: EXT MTL

ASSEMBLY: IBC 721.1(2) ITEM 15-1.4

DESCRIPTION: TYPICAL EXTERIOR WALL 1-HR RATED

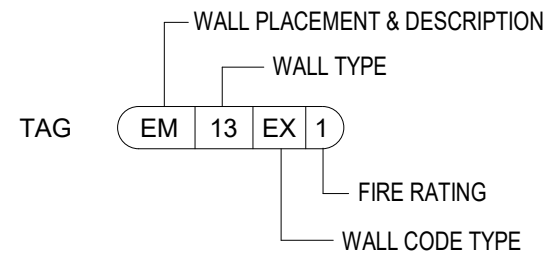

NAME: EM\_F\_13\_1 (3KS\_3KS)

COMMENT: EXT MTL

ASSEMBLY: N/A

DESCRIPTION: EXTERIOR WALL WITH STUCCO ON BOTH SIDES 1-HR RATED

1 COAT STUCCO

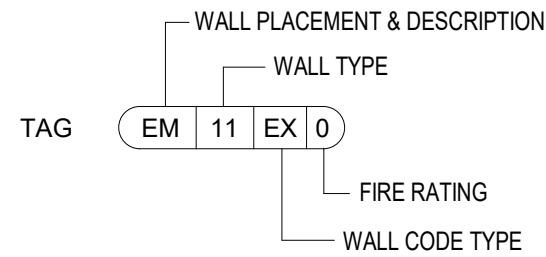

NAME: EM\_F\_11\_0 (1KS\_1GB)

COMMENT: EXT MTL

ASSEMBLY: N/A

DESCRIPTION: TYPICAL EXTERIOR WALL NON-RATED

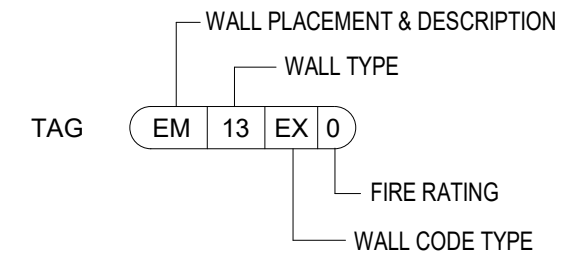

NAME: EM\_F\_13\_0 (1KS\_1KS)

COMMENT: EXT MTL

ASSEMBLY: N/A

DESCRIPTION: EXTERIOR WALL WITH STUCCO ON BOTH SIDES NON-RATED

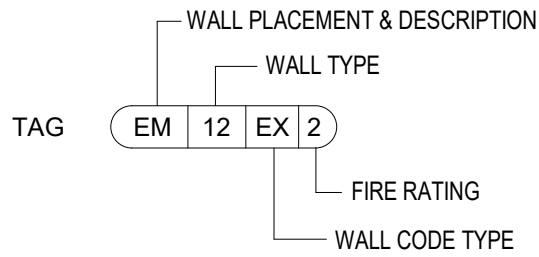

NAME: EM\_F\_12\_2 (3KS\_2GB)

COMMENT: EXT MTL

ASSEMBLY: UL U423

DESCRIPTION: TYPICAL EXTERIOR WALL 2-HR RATED

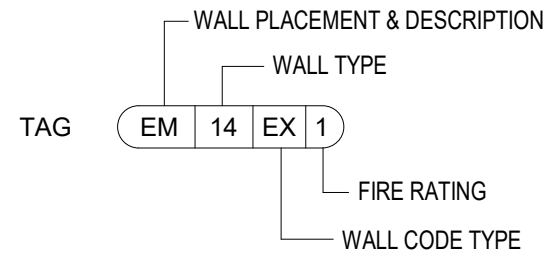

NAME: EM\_F\_14\_1 (3KS\_NA) Unit Separation

COMMENT: EXT MTL

ASSEMBLY: GA WP 5040

DESCRIPTION: UNIT SEPARATION WALL WITH STUCCO

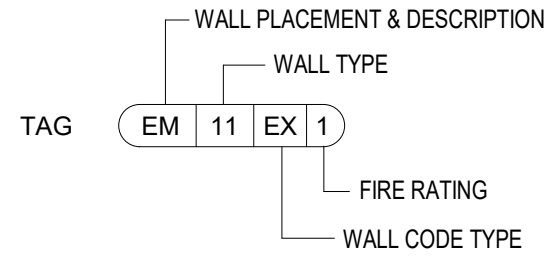

NAME: EM\_F\_11\_1 (1KS\_1GB)

COMMENT: EXT MTL

ASSEMBLY: IBC 721.1 (2)\_ITEM 15-1.11

DESCRIPTION: TYPICAL EXTERIOR WALL 1-HR RATED

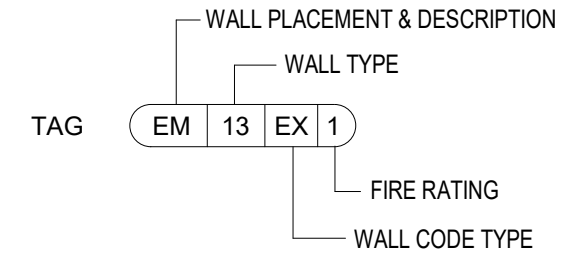

NAME: EM\_F\_13\_1 (1KS\_1KS)

COMMENT: EXT MTL

ASSEMBLY: IBC 721.1 (2)\_ITEM 15-1.11

DESCRIPTION: EXTERIOR WALL WITH STUCCO ON BOTH SIDES 1-HR RATED

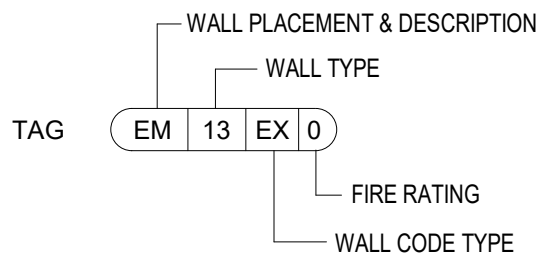

NAME: EM\_F\_13\_0 (3KS\_3KS)

COMMENT: EXT MTL

ASSEMBLY: N/A

DESCRIPTION: EXTERIOR WALL WITH STUCCO ON BOTH SIDES NON-RATED

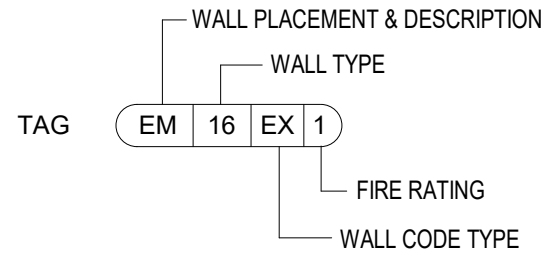

NAME: EM\_F\_16\_1 (3KS\_1GB)

COMMENT: EXT WD

ASSEMBLY: UL U423

DESCRIPTION: TYPICAL EXTERIOR WALL 1-HR RATED FROM BOTH SIDES

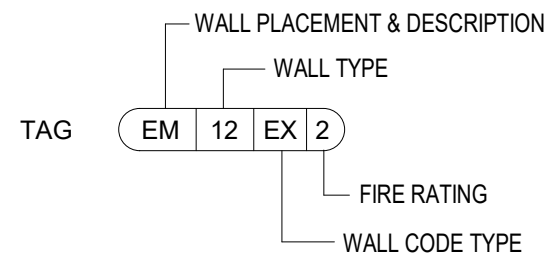

NAME: EM\_F\_12\_2 (1KS\_2GB)

COMMENT: EXT MTL

ASSEMBLY: IBC 721.1 (2)\_ITEM 15-1.10

DESCRIPTION: TYPICAL EXTERIOR WALL 2-HR RATED

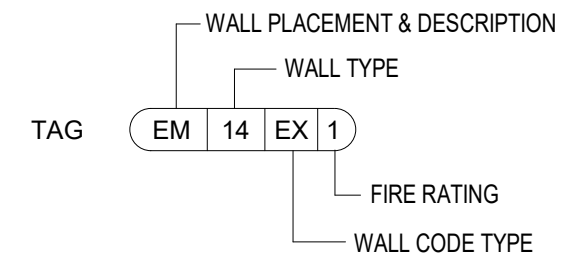

NAME: EM\_F\_14\_1 (1KS\_NA) Unit Separation

COMMENT: EXT MTL

ASSEMBLY: IBC 721.1 (2)\_ITEM 15-1.11

DESCRIPTION: UNIT SEPARATION WALL WITH STUCCO



**ORB ASSEMBLIES**  
EXTERIOR METAL STUD WALLS

**02-EM-F-01**

DATE:  
04/11/23

Autodesk Docs: //00-000-Revit-Detail-Library/4\_ORB-Assemblies-Split-Walls\_2023.rvt 2/5/2024 5:15:00 PM

**BRICK VENEER**

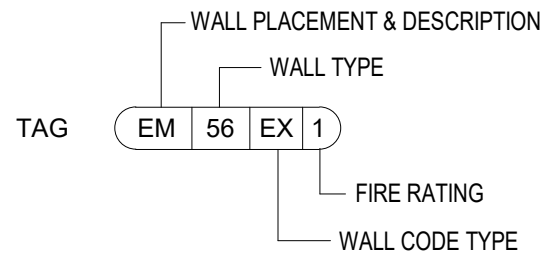

NAME: EMV\_F\_56\_1 (BV\_1GB)

COMMENT: VENEER ON EXT MTL

ASSEMBLY: GA WP 8006

DESCRIPTION: WALL WITH BRICK VENEER - GYP INSIDE

**METAL SIDING**

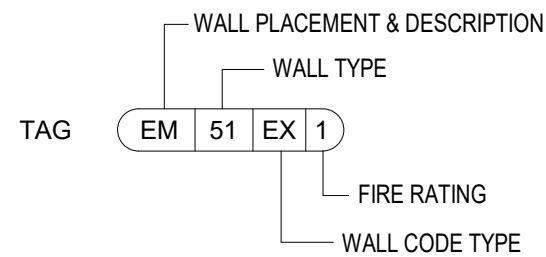

NAME: EMV\_F\_51\_1 (Mtl.S\_1GB)

COMMENT: VENEER ON EXT MTL

ASSEMBLY: GA WP 8006

DESCRIPTION: WALL WITH METAL SIDING VENEER - GYP INSIDE

**CEMENT BOARD**

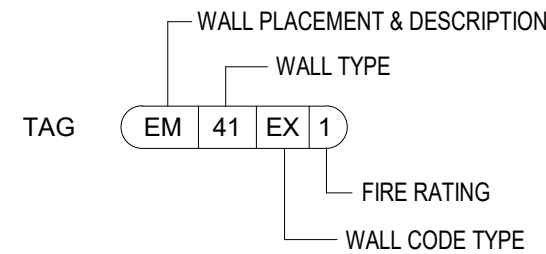

NAME: EMV\_F\_41\_1 (CB\_1GB)

COMMENT: VENEER ON EXT MTL

ASSEMBLY: GA WP 8006

DESCRIPTION: WALL WITH CEMENT BOARD - GYP INSIDE

**EIFS METAL STUD**

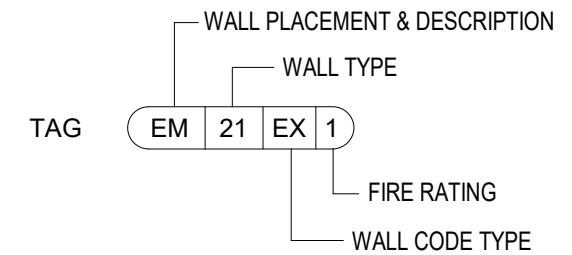

NAME: EM\_F\_21\_1 (EIFS\_1GB)

COMMENT: EXT MTL

ASSEMBLY: GA WP 8006

DESCRIPTION: TYPICAL EXTERIOR WALL 1-HR RATED

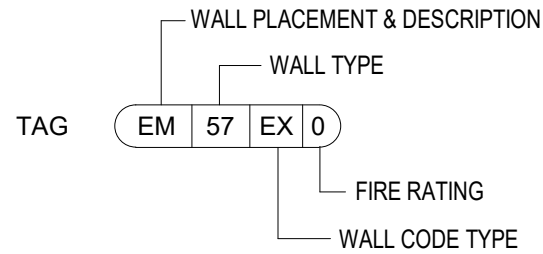

NAME: EMV\_F\_57\_0 (BV\_3KS)

COMMENT: VENEER ON EXT MTL

ASSEMBLY: N/A

DESCRIPTION: WALL WITH BRICK VENEER - STUCCO INSIDE

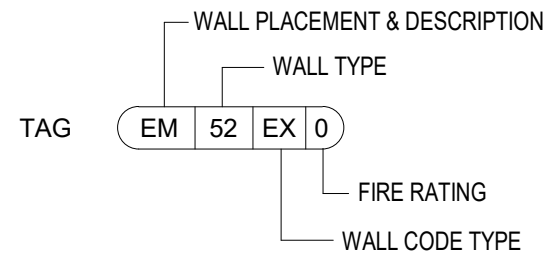

NAME: EMV\_F\_52\_0 (Mtl.S\_3KS)

COMMENT: VENEER ON EXT MTL

ASSEMBLY: N/A

DESCRIPTION: WALL WITH METAL SIDING VENEER - STUCCO INSIDE

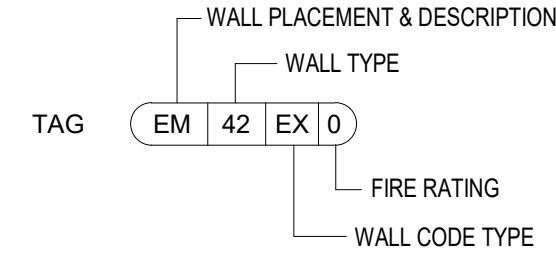

NAME: EMV\_F\_42\_0 (CB\_3KS)

COMMENT: VENEER ON EXT WD

ASSEMBLY: N/A

DESCRIPTION: WALL WITH CEMENT BOARD - STUCCO INSIDE

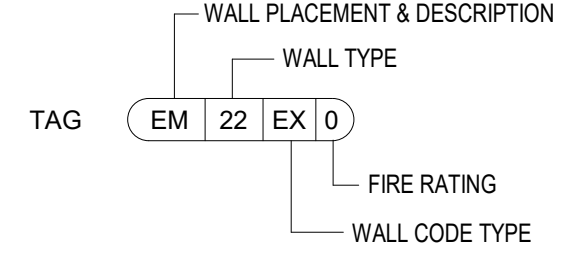

NAME: EM\_F\_22\_0 (EIFS\_1GB)

COMMENT: EXT MTL

ASSEMBLY: N/A

DESCRIPTION: EXTERIOR WALL WITH EIFS ON BOTH SIDES NON-RATED



**ORB ASSEMBLIES**

**EXTERIOR METAL STUD WALLS**

**02-EM-F-02**

DATE:  
04/11/23



**HARDIE PLANK**

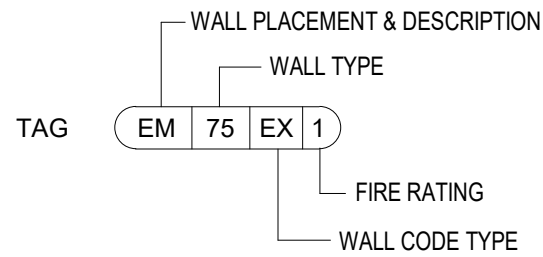

NAME: EMH\_F\_75\_1 (HP\_1GB)  
 COMMENT: HARDIE PLANK ON EXT WD  
 ASSEMBLY: GA WP 8006  
 DESCRIPTION: WALL WITH METAL SIDING VENEER - GYP INSIDE

**STONE VENEER**

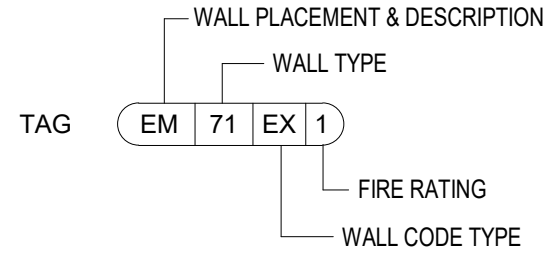

NAME: EMV\_F\_71\_1 (SV\_1GB)  
 COMMENT: VENEER ON EXT MTL  
 ASSEMBLY: GA WP 8006  
 DESCRIPTION: WALL WITH STONE VENEER - GYP INSIDE

**PRECAST VENEER**

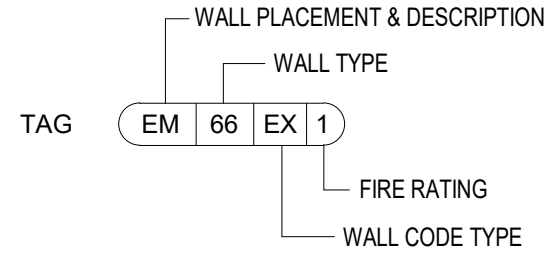

NAME: EMV\_F\_66\_1 (CV\_1GB)  
 COMMENT: VENEER ON EXT MTL  
 ASSEMBLY: GA WP 8006  
 DESCRIPTION: WALL WITH PRECAST VENEER - GYP INSIDE

**CMU VENEER**

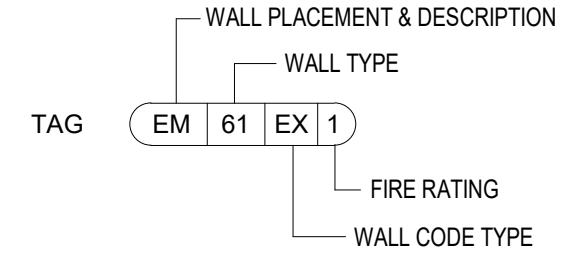

NAME: EMV\_F\_61\_1 (UV\_1GB)  
 COMMENT: VENEER ON EXT MTL  
 ASSEMBLY: GA WP 8006  
 DESCRIPTION: WALL WITH CMU VENEER - GYP INSIDE

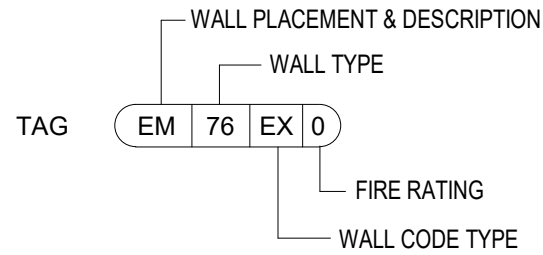

NAME: EMH\_F\_76\_0 (HP\_N/A)  
 COMMENT: HARDIE PLANK ON EXT WD  
 ASSEMBLY: N/A  
 DESCRIPTION: WALL WITH HARDIE PLANK - STUCCO INSIDE

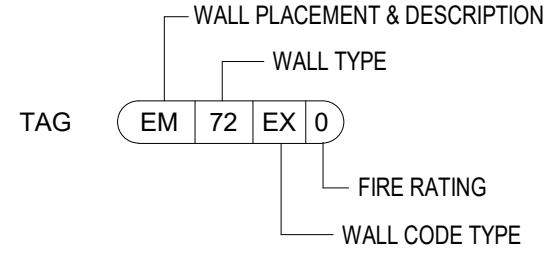

NAME: EMV\_F\_72\_0 (SV\_3KS)  
 COMMENT: VENEER ON EXT MTL  
 ASSEMBLY: N/A  
 DESCRIPTION: WALL WITH STONE VENEER - STUCCO INSIDE

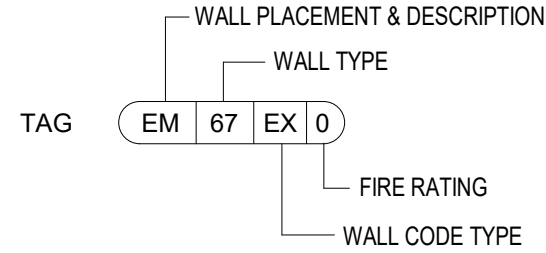

NAME: EMV\_F\_67\_0 (CV\_3KS)  
 COMMENT: VENEER ON EXT MTL  
 ASSEMBLY: N/A  
 DESCRIPTION: WALL WITH PRECAST VENEER - STUCCO INSIDE

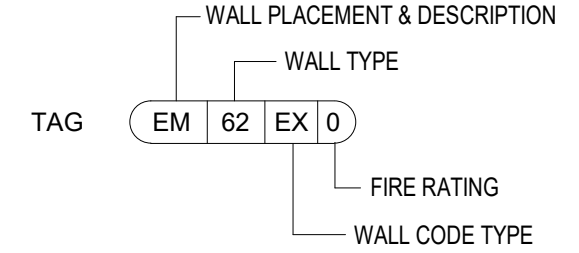

NAME: EMV\_F\_62\_0 (UV\_3KS)  
 COMMENT: VENEER ON EXT MTL  
 ASSEMBLY: N/A  
 DESCRIPTION: WALL WITH CMU VENEER - STUCCO INSIDE

**ORB ASSEMBLIES**  
 EXTERIOR METAL STUD WALLS

**02-EM-F-03**

DATE:  
04/11/23

Autodesk Docs: //00-000-Revit-Detail-Library/4\_ORB-Assemblies-Split-Walls\_2023.rvt 2/5/2024 5:15:02 PM



WALL PLACEMENT & DESCRIPTION

WALL TYPE

TAG EW S EX 0

FIRE RATING

WALL CODE TYPE

NAME: EW\_S\_0 (4\_1GB)

COMMENT: EXT WD

ASSEMBLY:

DESCRIPTION: TYPICAL EXTERIOR WALL NON-RATED



WALL PLACEMENT & DESCRIPTION

WALL TYPE

TAG EW S EX 0

FIRE RATING

WALL CODE TYPE

NAME: EW\_S\_0 (4\_NA)

COMMENT: EXT WD

ASSEMBLY:

DESCRIPTION: NON-RATED EXTERIOR WALL AT POP-OUTS (NO GYP INSIDE)



WALL PLACEMENT & DESCRIPTION

WALL TYPE

TAG EW S EX 0

FIRE RATING

WALL CODE TYPE

NAME: EW\_S\_0 (6\_3KS)

COMMENT: EXT WD

ASSEMBLY:

DESCRIPTION: EXTERIOR WALL WITH STUCCO ON BOTH SIDES NON-RATED



WALL PLACEMENT & DESCRIPTION

WALL TYPE

TAG EW S EX 0

FIRE RATING

WALL CODE TYPE

NAME: EW\_S\_0 (8\_1KS)

COMMENT: EXT WD

ASSEMBLY:

DESCRIPTION: EXTERIOR WALL WITH STUCCO ON BOTH SIDES NON-RATED



WALL PLACEMENT & DESCRIPTION

WALL TYPE

TAG EW S EX 0

FIRE RATING

WALL CODE TYPE

NAME: EW\_S\_0 (4\_1KS)

COMMENT: EXT WD

ASSEMBLY:

DESCRIPTION: EXTERIOR WALL WITH STUCCO ON BOTH SIDES NON-RATED



WALL PLACEMENT & DESCRIPTION

WALL TYPE

TAG EW S EX 0

FIRE RATING

WALL CODE TYPE

NAME: EW\_S\_0 (6\_1GB)

COMMENT: EXT WD

ASSEMBLY:

DESCRIPTION: TYPICAL EXTERIOR WALL NON-RATED



WALL PLACEMENT & DESCRIPTION

WALL TYPE

TAG EW S EX 0

FIRE RATING

WALL CODE TYPE

NAME: EW\_S\_0 (6\_NA)

COMMENT: EXT WD

ASSEMBLY:

DESCRIPTION: NON-RATED EXTERIOR WALL AT POP-OUTS (NO GYP INSIDE)



WALL PLACEMENT & DESCRIPTION

WALL TYPE

TAG EW S EX 0

FIRE RATING

WALL CODE TYPE

NAME: EW\_S\_0 (8\_3KS)

COMMENT: EXT WD

ASSEMBLY:

DESCRIPTION: EXTERIOR WALL WITH STUCCO ON BOTH SIDES NON-RATED



WALL PLACEMENT & DESCRIPTION

WALL TYPE

TAG EW S EX 0

FIRE RATING

WALL CODE TYPE

NAME: EW\_S\_0 (4\_3KS)

COMMENT: EXT WD

ASSEMBLY:

DESCRIPTION: EXTERIOR WALL WITH STUCCO ON BOTH SIDES NON-RATED



WALL PLACEMENT & DESCRIPTION

WALL TYPE

TAG EW S EX 0

FIRE RATING

WALL CODE TYPE

NAME: EW\_S\_0 (6\_1KS)

COMMENT: EXT WD

ASSEMBLY:

DESCRIPTION: EXTERIOR WALL WITH STUCCO ON BOTH SIDES NON-RATED



WALL PLACEMENT & DESCRIPTION

WALL TYPE

TAG EW S EX 0

FIRE RATING

WALL CODE TYPE

NAME: EW\_S\_0 (8\_1GB)

COMMENT: EXT WD

ASSEMBLY:

DESCRIPTION: TYPICAL EXTERIOR WALL NON-RATED



WALL PLACEMENT & DESCRIPTION

WALL TYPE

TAG EW S EX 0

FIRE RATING

WALL CODE TYPE

NAME: EW\_S\_0 (8\_NA)

COMMENT: EXT WD

ASSEMBLY:

DESCRIPTION: NON-RATED EXTERIOR WALL AT POP-OUTS (NO GYP INSIDE)



**ORB ASSEMBLIES**

EXTERIOR WOOD STRUCTURE WALLS

**03-EW-S-00**

DATE:  
FEBRUARY 24, 2020

Autodesk Docs: //00-000-Revit-Detail-Library/4\_ORB-Assemblies-Split-Walls\_2023.rvt 2/5/2024 5:15:02 PM



**ORB ASSEMBLIES**  
EXTERIOR WOOD STRUCTURE WALLS

**03-EW-S-01**

DATE:  
04/04/20



WALL PLACEMENT & DESCRIPTION

WALL TYPE

TAG EW S EX 1

FIRE RATING

WALL CODE TYPE

NAME: EW\_S\_1 (4\_1GB)  
COMMENT: EXT WD  
ASSEMBLY:  
DESCRIPTION: TYPICAL EXTERIOR WALL 1-HR RATED



WALL PLACEMENT & DESCRIPTION

WALL TYPE

TAG EW S EX 1

FIRE RATING

WALL CODE TYPE

NAME: EW\_S\_1 (4\_NA)  
COMMENT: EXT WD  
ASSEMBLY:  
DESCRIPTION: TYPICAL EXTERIOR WALL AT POP-OUTS (NO GYP INSIDE)



WALL PLACEMENT & DESCRIPTION

WALL TYPE

TAG EW S EX 1

FIRE RATING

WALL CODE TYPE

NAME: EW\_S\_1 (6\_1KS)  
COMMENT: EXT WD  
ASSEMBLY:  
DESCRIPTION: EXTERIOR WALL WITH STUCCO ON BOTH SIDES 1-HR RATED



WALL PLACEMENT & DESCRIPTION

WALL TYPE

TAG EW S EX 1

FIRE RATING

WALL CODE TYPE

NAME: EW\_S\_1 (6\_NA) Unit Separation  
COMMENT: EXT WD  
ASSEMBLY:  
DESCRIPTION: UNIT SEPARATION WALL WITH STUCCO



WALL PLACEMENT & DESCRIPTION

WALL TYPE

TAG EW S EX 1

FIRE RATING

WALL CODE TYPE

NAME: EW\_S\_1 (6\_1GB)  
COMMENT: EXT WD  
ASSEMBLY:  
DESCRIPTION: TYPICAL EXTERIOR WALL 1-HR RATED



WALL PLACEMENT & DESCRIPTION

WALL TYPE

TAG EW S EX 1

FIRE RATING

WALL CODE TYPE

NAME: EW\_S\_1 (4\_NA) Unit Separation  
COMMENT: EXT WD  
ASSEMBLY:  
DESCRIPTION: UNIT SEPARATION WALL WITH STUCCO



WALL PLACEMENT & DESCRIPTION

WALL TYPE

TAG EW S EX 1

FIRE RATING

WALL CODE TYPE

NAME: EW\_S\_1 (6\_3KS)  
COMMENT: EXT WD  
ASSEMBLY:  
DESCRIPTION: EXTERIOR WALL WITH STUCCO ON BOTH SIDES 1-HR RATED



WALL PLACEMENT & DESCRIPTION

WALL TYPE

TAG EW S EX 1

FIRE RATING

WALL CODE TYPE

NAME: EW\_S\_1 (8\_1GB)  
COMMENT: EXT WD  
ASSEMBLY:  
DESCRIPTION: TYPICAL EXTERIOR WALL 1-HR RATED

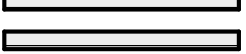

WALL PLACEMENT & DESCRIPTION

WALL TYPE

TAG EW S EX 1

FIRE RATING

WALL CODE TYPE

NAME: EW\_S\_1 (4\_3KS)  
COMMENT: EXT WD  
ASSEMBLY:  
DESCRIPTION: EXTERIOR WALL WITH STUCCO ON BOTH SIDES 1-HR RATED



WALL PLACEMENT & DESCRIPTION

WALL TYPE

TAG EW S EX 1

FIRE RATING

WALL CODE TYPE

NAME: EW\_S\_1 (6\_1GB)  
COMMENT: EXT WD  
ASSEMBLY:  
DESCRIPTION: TYPICAL EXTERIOR WALL 1-HR RATED



WALL PLACEMENT & DESCRIPTION

WALL TYPE

TAG EW S EX 1

FIRE RATING

WALL CODE TYPE

NAME: EW\_S\_1 (6\_NA)  
COMMENT: EXT WD  
ASSEMBLY:  
DESCRIPTION: TYPICAL EXTERIOR WALL AT POP-OUTS (NO GYP INSIDE)



WALL PLACEMENT & DESCRIPTION

WALL TYPE

TAG EW S EX 1

FIRE RATING

WALL CODE TYPE

NAME: EW\_S\_1 (8\_1KS)  
COMMENT: EXT WD  
ASSEMBLY:  
DESCRIPTION: EXTERIOR WALL WITH STUCCO ON BOTH SIDES 1-HR RATED

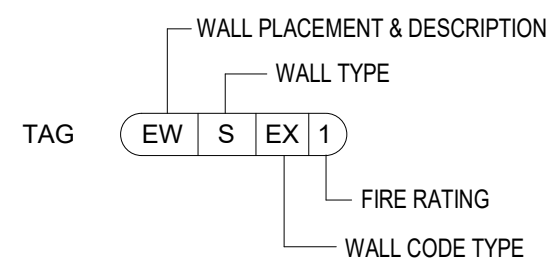

NAME: EW\_S\_1 (8\_3KS)

COMMENT: EXT WD

ASSEMBLY:

DESCRIPTION: EXTERIOR WALL WITH STUCCO ON BOTH SIDES 1-HR RATED

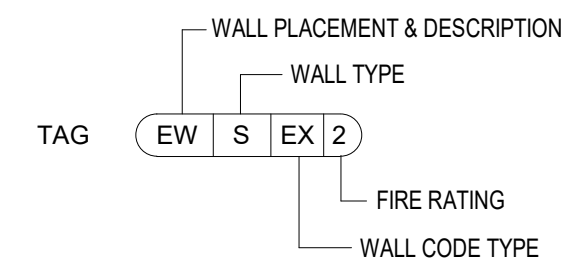

NAME: EW\_S\_2 (4\_2GB)

COMMENT: EXT WD

ASSEMBLY:

DESCRIPTION: TYPICAL EXTERIOR WALL 2-HR RATED

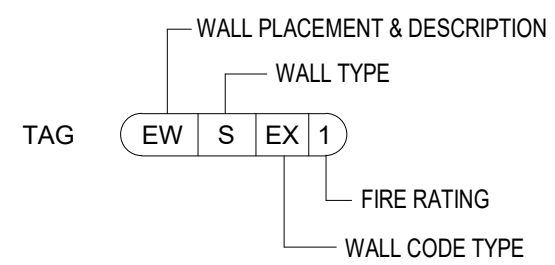
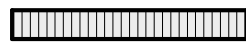

NAME: EW\_S\_1 (8\_NA)

COMMENT: EXT WD

ASSEMBLY:

DESCRIPTION: TYPICAL EXTERIOR WALL AT POP-OUTS (NO GYP INSIDE)

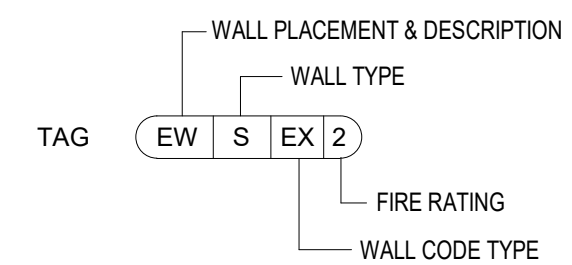

NAME: EW\_S\_2 (6\_2GB)

COMMENT: EXT WD

ASSEMBLY:

DESCRIPTION: TYPICAL EXTERIOR WALL 2-HR RATED

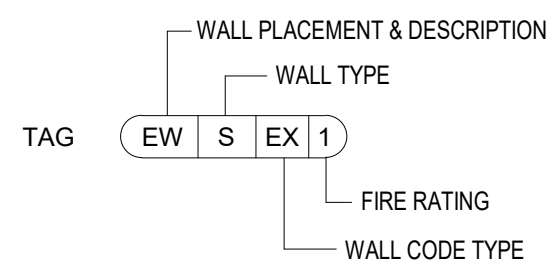

NAME: EW\_S\_1 (8\_NA) Unit Separation

COMMENT: EXT WD

ASSEMBLY:

DESCRIPTION: UNIT SEPARATION WALL WITH STUCCO

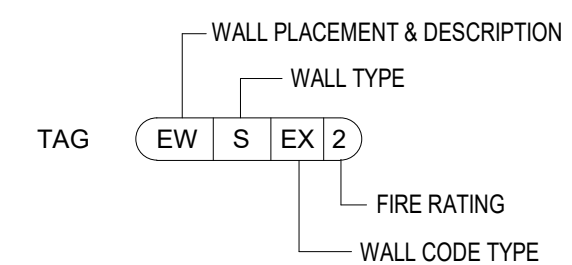

NAME: EW\_S\_2 (8\_2GB)

COMMENT: EXT WD

ASSEMBLY:

DESCRIPTION: TYPICAL EXTERIOR WALL 2-HR RATED



**ORB ASSEMBLIES**

EXTERIOR WOOD STRUCTURE WALLS

**03-EW-S-02**

DATE:  
04/04/20

Autodesk Docs: //00-000-Revit-Detail-Library/4\_ORB-Assemblies-Split-Walls\_2023.rvt 2/5/2024 5:15:03 PM



WALL PLACEMENT & DESCRIPTION

WALL TYPE

TAG EM S EX 0

FIRE RATING

WALL CODE TYPE

NAME: EM\_S\_0 (4\_1GB)

COMMENT: EXT MTL

ASSEMBLY:

DESCRIPTION: TYPICAL EXTERIOR WALL NON-RATED



WALL PLACEMENT & DESCRIPTION

WALL TYPE

TAG EM S EX 0

FIRE RATING

WALL CODE TYPE

NAME: EM\_S\_0 (4\_NA)

COMMENT: EXT MTL

ASSEMBLY:

DESCRIPTION: NON-RATED EXTERIOR WALL AT POP-OUTS (NO GYP INSIDE)



WALL PLACEMENT & DESCRIPTION

WALL TYPE

TAG EM S EX 0

FIRE RATING

WALL CODE TYPE

NAME: EM\_S\_0 (6\_3KS)

COMMENT: EXT MTL

ASSEMBLY:

DESCRIPTION: EXTERIOR WALL WITH STUCCO ON BOTH SIDES NON-RATED



WALL PLACEMENT & DESCRIPTION

WALL TYPE

TAG EM S EX 0

FIRE RATING

WALL CODE TYPE

NAME: EM\_S\_0 (8\_1KS)

COMMENT: EXT MTL

ASSEMBLY:

DESCRIPTION: EXTERIOR WALL WITH STUCCO ON BOTH SIDES NON-RATED



WALL PLACEMENT & DESCRIPTION

WALL TYPE

TAG EM S EX 0

FIRE RATING

WALL CODE TYPE

NAME: EM\_S\_0 (4\_1KS)

COMMENT: EXT MTL

ASSEMBLY:

DESCRIPTION: EXTERIOR WALL WITH STUCCO ON BOTH SIDES NON-RATED



WALL PLACEMENT & DESCRIPTION

WALL TYPE

TAG EM S EX 0

FIRE RATING

WALL CODE TYPE

NAME: EM\_S\_0 (6\_1GB)

COMMENT: EXT MTL

ASSEMBLY:

DESCRIPTION: TYPICAL EXTERIOR WALL NON-RATED



WALL PLACEMENT & DESCRIPTION

WALL TYPE

TAG EM S EX 0

FIRE RATING

WALL CODE TYPE

NAME: EM\_S\_0 (6\_NA)

COMMENT: EXT MTL

ASSEMBLY:

DESCRIPTION: NON-RATED EXTERIOR WALL AT POP-OUTS (NO GYP INSIDE)



WALL PLACEMENT & DESCRIPTION

WALL TYPE

TAG EM S EX 0

FIRE RATING

WALL CODE TYPE

NAME: EM\_S\_0 (8\_3KS)

COMMENT: EXT MTL

ASSEMBLY:

DESCRIPTION: EXTERIOR WALL WITH STUCCO ON BOTH SIDES NON-RATED



WALL PLACEMENT & DESCRIPTION

WALL TYPE

TAG EM S EX 0

FIRE RATING

WALL CODE TYPE

NAME: EM\_S\_0 (4\_3KS)

COMMENT: EXT MTL

ASSEMBLY:

DESCRIPTION: EXTERIOR WALL WITH STUCCO ON BOTH SIDES NON-RATED



WALL PLACEMENT & DESCRIPTION

WALL TYPE

TAG EM S EX 0

FIRE RATING

WALL CODE TYPE

NAME: EM\_S\_0 (6\_1KS)

COMMENT: EXT MTL

ASSEMBLY:

DESCRIPTION: EXTERIOR WALL WITH STUCCO ON BOTH SIDES NON-RATED



WALL PLACEMENT & DESCRIPTION

WALL TYPE

TAG EM S EX 0

FIRE RATING

WALL CODE TYPE

NAME: EM\_S\_0 (8\_1GB)

COMMENT: EXT MTL

ASSEMBLY:

DESCRIPTION: TYPICAL EXTERIOR WALL NON-RATED



WALL PLACEMENT & DESCRIPTION

WALL TYPE

TAG EM S EX 0

FIRE RATING

WALL CODE TYPE

NAME: EM\_S\_0 (8\_NA)

COMMENT: EXT MTL

ASSEMBLY:

DESCRIPTION: NON-RATED EXTERIOR WALL AT POP-OUTS (NO GYP INSIDE)



**ORB ASSEMBLIES**

EXTERIOR METAL STUD STRUCTURE WALLS

**04-EM-S-00**

DATE: 04/04/20

2/5/2024 5:15:04 PM  
Autodesk Docs: //00-000\_Revit\_Detail\_Library/4\_ORB\_Assemblies\_Split\_Walls\_2023.rvt



**ORB ASSEMBLIES**  
EXTERIOR METAL STUD STRUCTURE WALLS



WALL PLACEMENT & DESCRIPTION

WALL TYPE

TAG: EM S EX 1

FIRE RATING

WALL CODE TYPE

NAME: EM\_S\_1 (4\_1GB)  
COMMENT: EXT MTL  
ASSEMBLY:  
DESCRIPTION: TYPICAL EXTERIOR WALL 1-HR RATED



WALL PLACEMENT & DESCRIPTION

WALL TYPE

TAG: EM S EX 1

FIRE RATING

WALL CODE TYPE

NAME: EM\_S\_1 (4\_NA)  
COMMENT: EXT MTL  
ASSEMBLY:  
DESCRIPTION: TYPICAL EXTERIOR WALL AT POP-OUTS (NO GYP INSIDE)



WALL PLACEMENT & DESCRIPTION

WALL TYPE

TAG: EM S EX 1

FIRE RATING

WALL CODE TYPE

NAME: EM\_S\_1 (6\_1KS)  
COMMENT: EXT MTL  
ASSEMBLY:  
DESCRIPTION: EXTERIOR WALL WITH STUCCO ON BOTH SIDES 1-HR RATED



WALL PLACEMENT & DESCRIPTION

WALL TYPE

TAG: EM S EX 1

FIRE RATING

WALL CODE TYPE

NAME: EM\_S\_1 (6\_NA) Unit Separation  
COMMENT: EXT MTL  
ASSEMBLY:  
DESCRIPTION: UNIT SEPARATION WALL WITH STUCCO



WALL PLACEMENT & DESCRIPTION

WALL TYPE

TAG: EM S EX 1

FIRE RATING

WALL CODE TYPE

NAME: EM\_S\_1 (4\_1KS)  
COMMENT: EXT MTL  
ASSEMBLY:  
DESCRIPTION: EXTERIOR WALL WITH STUCCO ON BOTH SIDES 1-HR RATED



WALL PLACEMENT & DESCRIPTION

WALL TYPE

TAG: EM S EX 1

FIRE RATING

WALL CODE TYPE

NAME: EM\_S\_1 (4\_NA) Unit Separation  
COMMENT: EXT MTL  
ASSEMBLY:  
DESCRIPTION: UNIT SEPARATION WALL WITH STUCCO



WALL PLACEMENT & DESCRIPTION

WALL TYPE

TAG: EM S EX 1

FIRE RATING

WALL CODE TYPE

NAME: EM\_S\_1 (6\_3KS)  
COMMENT: EXT MTL  
ASSEMBLY:  
DESCRIPTION: EXTERIOR WALL WITH STUCCO ON BOTH SIDES 1-HR RATED



WALL PLACEMENT & DESCRIPTION

WALL TYPE

TAG: EM S EX 1

FIRE RATING

WALL CODE TYPE

NAME: EM\_S\_1 (8\_1GB)  
COMMENT: EXT MTL  
ASSEMBLY:  
DESCRIPTION: TYPICAL EXTERIOR WALL 1-HR RATED



WALL PLACEMENT & DESCRIPTION

WALL TYPE

TAG: EM S EX 1

FIRE RATING

WALL CODE TYPE

NAME: EM\_S\_1 (4\_3KS)  
COMMENT: EXT MTL  
ASSEMBLY:  
DESCRIPTION: EXTERIOR WALL WITH STUCCO ON BOTH SIDES 1-HR RATED



WALL PLACEMENT & DESCRIPTION

WALL TYPE

TAG: EM S EX 1

FIRE RATING

WALL CODE TYPE

NAME: EM\_S\_1 (6\_1GB)  
COMMENT: EXT MTL  
ASSEMBLY:  
DESCRIPTION: TYPICAL EXTERIOR WALL 1-HR RATED



WALL PLACEMENT & DESCRIPTION

WALL TYPE

TAG: EM S EX 1

FIRE RATING

WALL CODE TYPE

NAME: EM\_S\_1 (6\_NA)  
COMMENT: EXT WD  
ASSEMBLY:  
DESCRIPTION: TYPICAL EXTERIOR WALL AT POP-OUTS (NO GYP INSIDE)



WALL PLACEMENT & DESCRIPTION

WALL TYPE

TAG: EM S EX 1

FIRE RATING

WALL CODE TYPE

NAME: EM\_S\_1 (8\_1KS)  
COMMENT: EXT MTL  
ASSEMBLY:  
DESCRIPTION: EXTERIOR WALL WITH STUCCO ON BOTH SIDES 1-HR RATED

**04-EM-S-01**  
DATE: 04/04/20

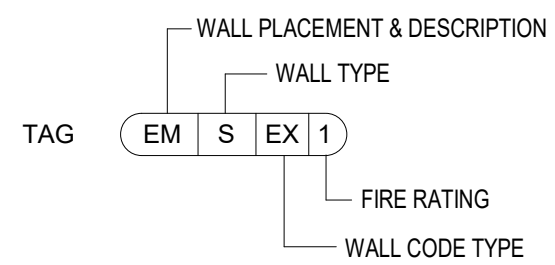

NAME: EM\_S\_1 (8\_3KS)

COMMENT: EXT MTL

ASSEMBLY:

DESCRIPTION: EXTERIOR WALL WITH STUCCO ON BOTH SIDES 1-HR RATED

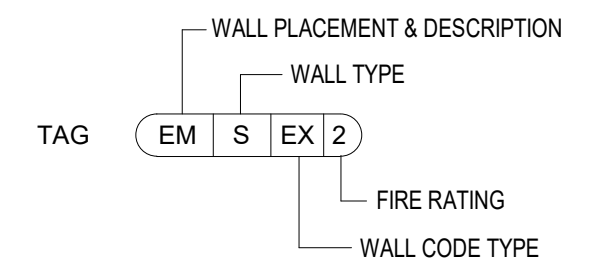

NAME: EM\_S\_2 (4\_2GB)

COMMENT: EXT MTL

ASSEMBLY:

DESCRIPTION: TYPICAL EXTERIOR WALL 2-HR RATED

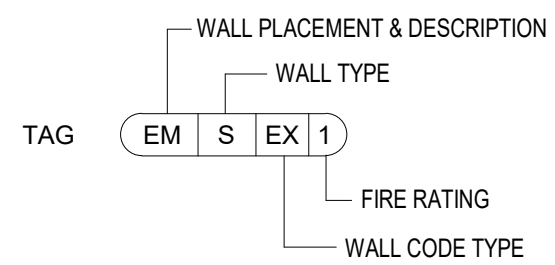

NAME: EM\_S\_1 (8\_NA)

COMMENT: EXT MTL

ASSEMBLY:

DESCRIPTION: TYPICAL EXTERIOR WALL AT POP-OUTS (NO GYP INSIDE)

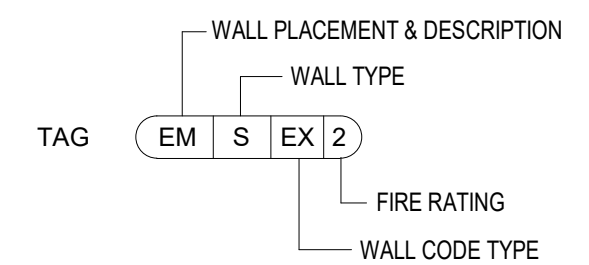

NAME: EM\_S\_2 (6\_2GB)

COMMENT: EXT MTL

ASSEMBLY:

DESCRIPTION: TYPICAL EXTERIOR WALL 2-HR RATED

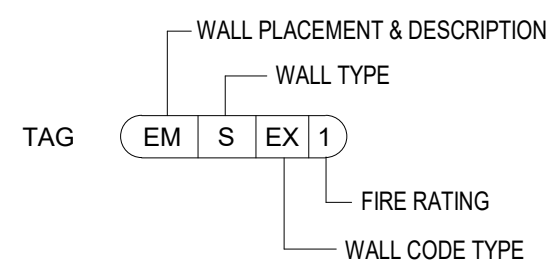

NAME: EM\_S\_1 (8\_NA) Unit Separation

COMMENT: EXT MTL

ASSEMBLY:

DESCRIPTION: UNIT SEPARATION WALL WITH STUCCO

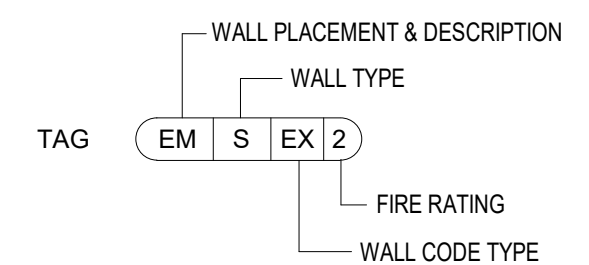

NAME: EM\_S\_2 (8\_2GB)

COMMENT: EXT MTL

ASSEMBLY:

DESCRIPTION: TYPICAL EXTERIOR WALL 2-HR RATED



**ORB ASSEMBLIES**  
EXTERIOR METAL STUD STRUCTURE WALLS

**04-EM-S-02**

DATE:  
04/04/20

Autodesk Docs: //00-000-Revit-Detail-Library/4\_ORB-Assemblies-Split-Walls\_2023.rvt 2/5/2024 5:15:05 PM

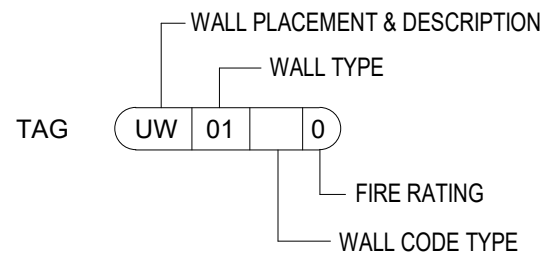

NAME: UW\_01\_0 (NA\_8x8x16\_NA)

COMMENT: CMU

ASSEMBLY: N/A

DESCRIPTION: TYPICAL CMU WALL  
NON-RATED

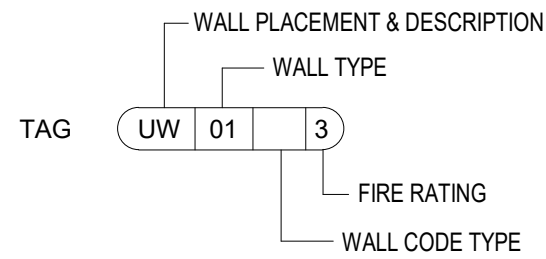

NAME: UW\_01\_3 (NA\_8x8x16\_NA)

COMMENT: CMU

ASSEMBLY: IBC 721.1 (2) 3-1.1/ 3-1.4

DESCRIPTION: TYPICAL CMU WALL-3-HR  
RATED

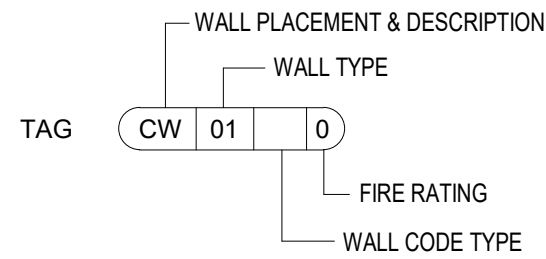

NAME: CW\_01\_0 (NA\_8\_NA)

COMMENT: CONC

ASSEMBLY: N/A

DESCRIPTION: TYPICAL CONCRETE WALL  
NON-RATED

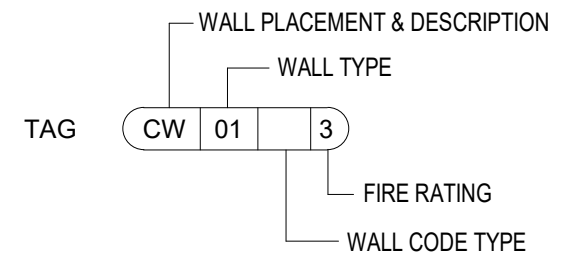

NAME: CW\_01\_3 (NA\_8\_NA)

COMMENT: CONC

ASSEMBLY: IBC 721.1 (2) 4-1.1

DESCRIPTION: TYPICAL CONCRETE WALL  
3-HR RATED

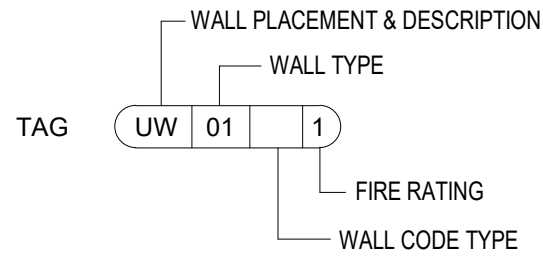

NAME: UW\_01\_1 (NA\_8x8x16\_NA)

COMMENT: CMU

ASSEMBLY: IBC 721.1 (2) 3-1.1/ 3-1.4

DESCRIPTION: TYPICAL CMU WALL  
1-HR-RATED

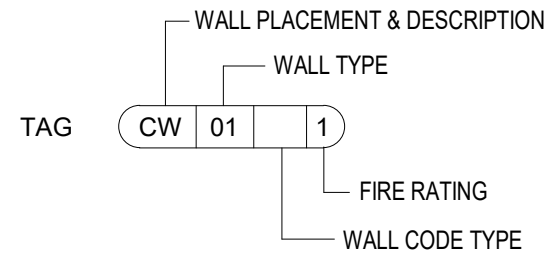

NAME: CW\_01\_1 (NA\_8\_NA)

COMMENT: CONC

ASSEMBLY: IBC 721.1 (2) 4-1.1

DESCRIPTION: TYPICAL CONCRETE WALL  
1-HR RATED

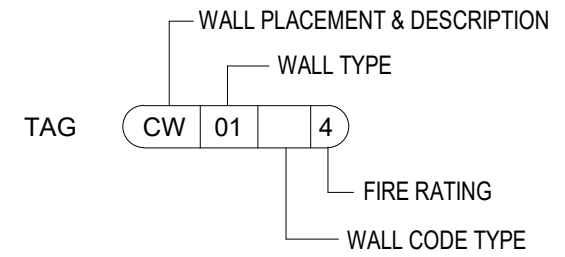

NAME: CW\_01\_4 (NA\_8\_NA)

COMMENT: CONC

ASSEMBLY: IBC 721.1 (2) 4-1.1

DESCRIPTION: TYPICAL CONCRETE WALL  
4-HR RATED

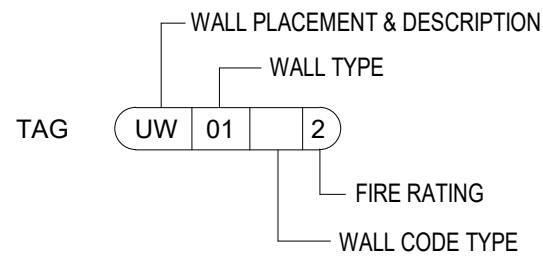

NAME: UW\_01\_2 (NA\_8x8x16\_NA)

COMMENT: CMU

ASSEMBLY: IBC 721.1 (2) 3-1.1/ 3-1.4

DESCRIPTION: TYPICAL CMU WALL  
2-HR-RATED

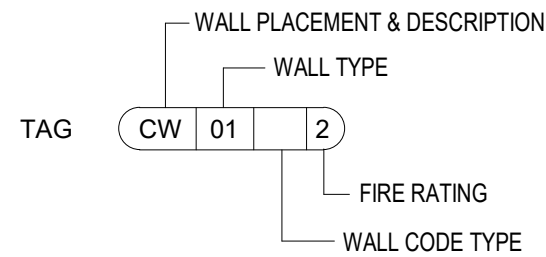
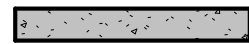

NAME: CW\_01\_2 (NA\_8\_NA)

COMMENT: CONC

ASSEMBLY: IBC 721.1 (2) 4-1.1

DESCRIPTION: TYPICAL CONCRETE WALL  
2-HR RATED



**ORB ASSEMBLIES**  
CMU & CONCRETE WALLS

**05-CONC-01**

DATE:  
04/04/20



2/5/2024 5:15:06 PM  
Autodesk Docs: //00-000\_Revit\_Detail\_Library/4\_ORB\_Assemblies\_Split\_Walls\_2023.rvt



**ORB ASSEMBLIES**  
**CMU WITH VENEER**

**05-CONC-02**

DATE:  
04/04/20

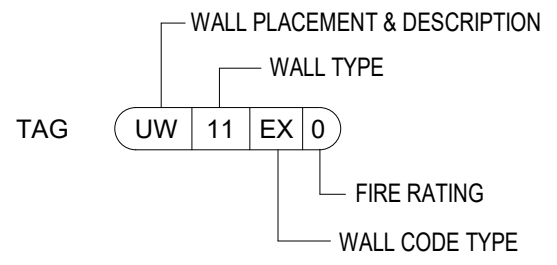
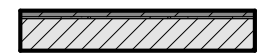

NAME: UWV\_11\_0 (BV\_8x8x16\_NA)  
COMMENT: CMU-V  
ASSEMBLY: N/A  
DESCRIPTION: CMU WALL WITH BRICK VENEER ON 1-SIDE NON-RATED

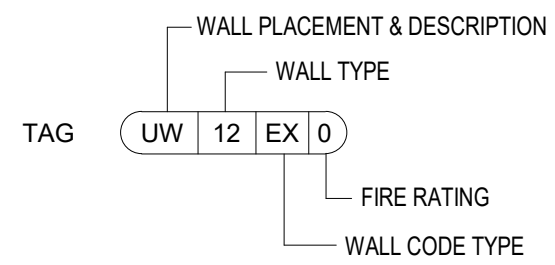
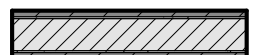

NAME: UWV\_12\_0 (BV\_8x8x16\_BV)  
COMMENT: CMU-V  
ASSEMBLY: N/A  
DESCRIPTION: CMU WALL WITH BRICK VENEER ON 2-SIDES NON-RATED

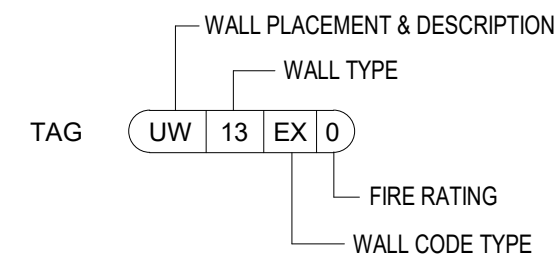
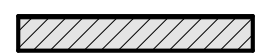

NAME: UWV\_13\_0 (3KS\_8x8x16\_NA)  
COMMENT: CMU-S  
ASSEMBLY:  
DESCRIPTION: CMU WALL WITH STUCCO FINISH ON 1-SIDE NON-RATED

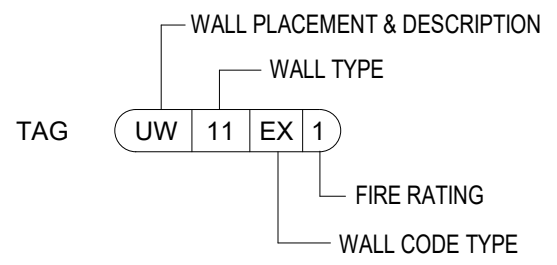
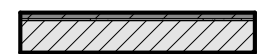

NAME: UWV\_11\_1 (BV\_8x8x16\_NA)  
COMMENT: CMU-V  
ASSEMBLY: IBC 721.1 (2) 3-1.1/ 3-1.4  
DESCRIPTION: CMU WALL WITH BRICK VENEER ON 1-SIDE 1-HR RATED

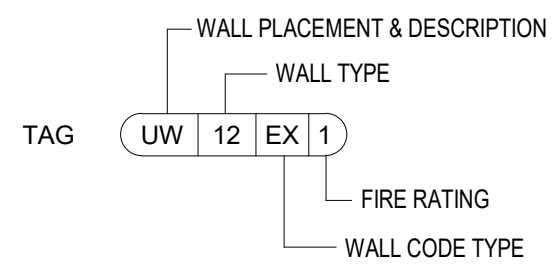

NAME: UWV\_12\_1 (BV\_8x8x16\_BV)  
COMMENT: CMU-V  
ASSEMBLY: IBC 721.1 (2) 3-1.1/ 3-1.4  
DESCRIPTION: CMU WALL WITH BRICK VENEER 2-SIDES 1-HR RATED

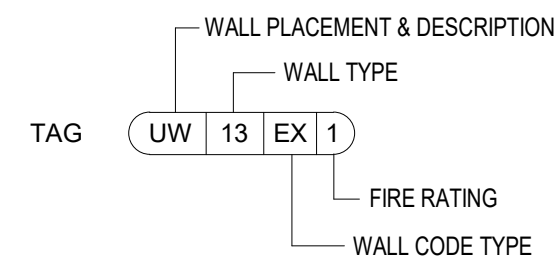

NAME: UWV\_13\_1 (3KS\_8x8x16\_NA)  
COMMENT: CMU-S  
ASSEMBLY: IBC 721.1 (2) 3-1.1/ 3-1.4  
DESCRIPTION: CMU WALL WITH STUCCO FINISH ON 1-SIDE 1-HR RATED

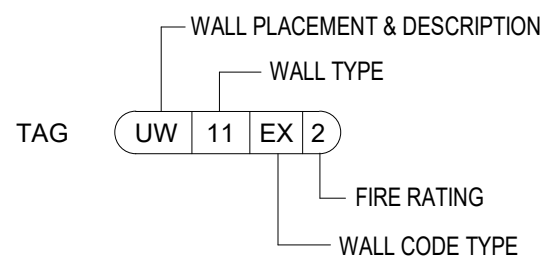
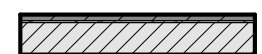

NAME: UWV\_11\_2 (BV\_8x8x16\_NA)  
COMMENT: CMU-V  
ASSEMBLY: IBC 721.1 (2) 3-1.1/ 3-1.4  
DESCRIPTION: CMU WALL WITH BRICK VENEER ON 1-SIDE 2-HR RATED

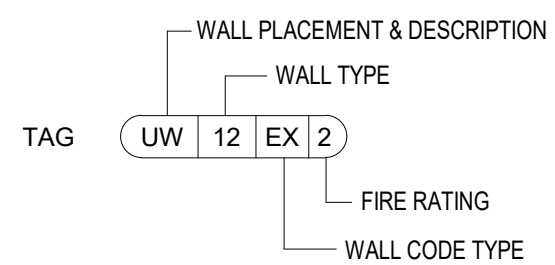

NAME: UWV\_12\_2 (BV\_8x8x16\_BV)  
COMMENT: CMU-V  
ASSEMBLY: IBC 721.1 (2) 3-1.1/ 3-1.4  
DESCRIPTION: CMU WALL WITH BRICK VENEER 2-SIDES 2-HR RATED

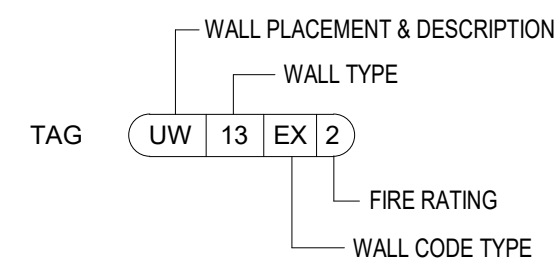

NAME: UWV\_13\_2 (3KS\_8x8x16\_NA)  
COMMENT: CMU-S  
ASSEMBLY: IBC 721.1 (2) 3-1.1/ 3-1.4  
DESCRIPTION: CMU WALL WITH STUCCO FINISH ON 1-SIDE 2-HR RATED

Autodesk Docs: //00-000\_Revit\_Detail\_Library/4\_ORB\_Assemblies\_Split\_Walls\_2023.rvt 2/5/2024 5:15:06 PM

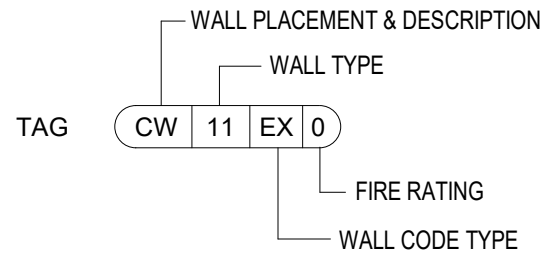
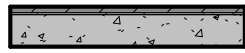

NAME: CWV\_11\_0 (BV\_8\_NA)

COMMENT: CONC-V

ASSEMBLY: N/A

DESCRIPTION: CONCRETE WALL WITH BRICK VENEER ON 1-SIDE NON-RATED

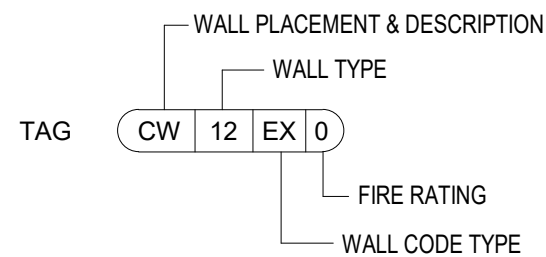

NAME: CWV\_12\_0 (BV\_8\_BV)

COMMENT: CONC-V

ASSEMBLY: N/A

DESCRIPTION: CONCRETE WALL WITH BRICK VENEER ON 2-SIDES NON-RATED

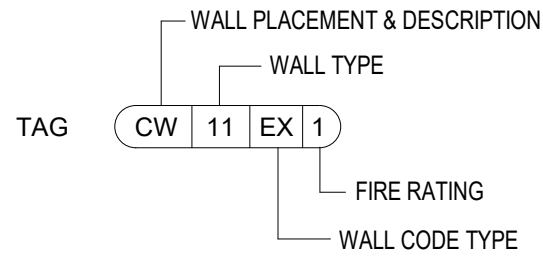

NAME: CWV\_11\_1 (BV\_8\_NA)

COMMENT: CONC-V

ASSEMBLY: IBC 721.1 (2) 4-1.1

DESCRIPTION: CONCRETE WALL WITH BRICK VENEER 1-SIDE 1-HR RATED

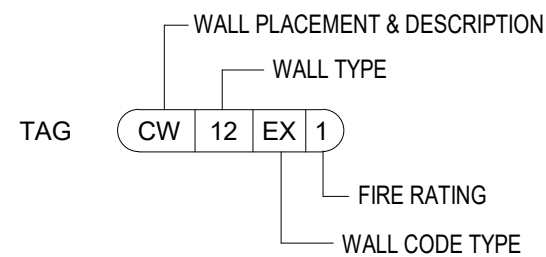
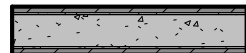

NAME: CWV\_12\_1 (BV\_8\_BV)

COMMENT: CONC-V

ASSEMBLY: IBC 721.1 (2) 4-1.1

DESCRIPTION: CONCRETE WALL WITH BRICK VENEER 2-SIDES 1-HR RATED

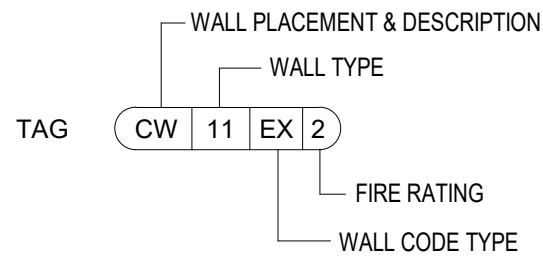
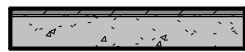

NAME: CWV\_11\_2 (BV\_8\_NA)

COMMENT: CONC-V

ASSEMBLY: IBC 721.1 (2) 4-1.1

DESCRIPTION: CONCRETE WALL WITH BRICK VENEER 1-SIDE 2-HR RATED

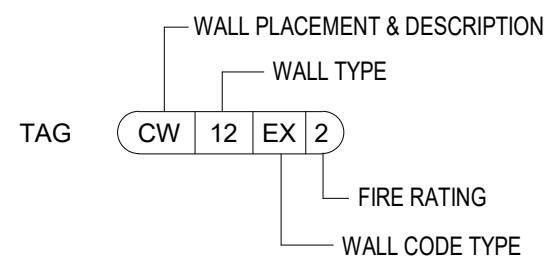
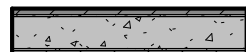

NAME: CWV\_12\_2 (BV\_8\_BV)

COMMENT: CONC-V

ASSEMBLY: IBC 721.1 (2) 4-1.1

DESCRIPTION: CONCRETE WALL WITH BRICK VENEER 2-SIDES 2-HR RATED



**ORB ASSEMBLIES**  
CONCRETE WALLS WITH VENEER

**05-CONC-03**

DATE:  
04/04/20

SHAFT WALLS

Autodesk Docs: //00-000\_Revit\_Detail\_Library/4\_ORB\_Assemblies\_Split\_Walls\_2023.rvt 2/5/2024 5:15:07 PM



WALL PLACEMENT & DESCRIPTION

WALL TYPE

TAG: FW 22 FW 2

FIRE RATING

WALL CODE TYPE

NAME: FW\_20\_2 (Liner 2GB 1")

COMMENT: LINER

ASSEMBLY: UL U347

DESCRIPTION: FIRE WALL 2" LINER 2-HR RATED AT INTERIOR 2x WOOD WALL ON EACH SIDE

INTERIOR SHAFT



WALL PLACEMENT & DESCRIPTION

WALL TYPE

TAG: SH 01 FB 2

FIRE RATING

WALL CODE TYPE

NAME: SH\_01\_2 (Liner 2GB 1")

COMMENT: LINER

ASSEMBLY: UL U347

DESCRIPTION: FIRE WALL 2" LINER 2-HR RATED AT INTERIOR 2x WOOD WALL EXTERIOR SIDE



WALL PLACEMENT & DESCRIPTION

WALL TYPE

TAG: FW 22 FW 2

FIRE RATING

WALL CODE TYPE

NAME: FW\_20\_2 (Liner 2GB 1")

COMMENT: LINER

ASSEMBLY: UL U347

DESCRIPTION: FIRE WALL 2" LINER 2-HR RATED AT INTERIOR 2x WOOD WALL ON EACH SIDE



WALL PLACEMENT & DESCRIPTION

WALL TYPE

TAG: FW 23 FW 3

FIRE RATING

WALL CODE TYPE

NAME: FW\_23\_3 (Liner 2GB 1")

COMMENT: LINER

ASSEMBLY: UL W454

DESCRIPTION: FIRE WALL 2" LINER 3-HR RATED AT EXTERIOR 2x WOOD WALL ON EACH SIDE



WALL PLACEMENT & DESCRIPTION

WALL TYPE

TAG: SH 02 FB 2

FIRE RATING

WALL CODE TYPE

NAME: SH\_02\_2 (Liner 2GB 4 1"GB) SHAFT

COMMENT: LINER

ASSEMBLY: UL U428

DESCRIPTION: SHAFT WALL 2.5" STUDS 2-HR RATED



WALL PLACEMENT & DESCRIPTION

WALL TYPE

TAG: FW 23 FW 3

FIRE RATING

WALL CODE TYPE

NAME: FW\_23\_3 (Liner 2GB 1")

COMMENT: LINER

ASSEMBLY: UL W454

DESCRIPTION: FIRE WALL 2" LINER 3-HR RATED AT EXTERIOR 2x WOOD WALL ON EACH SIDE



WALL PLACEMENT & DESCRIPTION

WALL TYPE

TAG: SH 04 FB 2

FIRE RATING

WALL CODE TYPE

NAME: SH\_04\_2 (Liner 2GB 4 1"GB) SHAFT

COMMENT: LINER

ASSEMBLY: UL U428

DESCRIPTION: SHAFT WALL 4" STUDS 2-HR RATED



**ORB ASSEMBLIES**  
FIRE WALLS AND SHAFT WALLS

**06-FW\*SW**

DATE:  
03/01/23

2/5/2024 5:15:07 PM  
Autodesk Docs: //00-000 Revit Detail Library/4\_ORB Assemblies Split\_Walls\_2023.rvt

RESILIENT CHANNEL  
W/ 1 LAYER OF GYPSUM BOARD



WALL PLACEMENT & DESCRIPTION

WALL TYPE

TAG: IW 02 FP 1

FIRE RATING

WALL CODE TYPE

NAME: IW\_02\_1 (1GB\_RS\_4\_1GB) Corridor  
COMMENT: INT WD  
ASSEMBLY: WP 3242  
DESCRIPTION: TYPICAL 2x4 CORRIDOR WALL 1-HR RATED W/ RESILIENT CHANNEL - 54 STC

(2) LAYERS OF GYPSUM BOARD ON CORRIDOR SIDE AND (1) LAYER ON UNIT SIDE



WALL PLACEMENT & DESCRIPTION

WALL TYPE

TAG: IW 02 FP 1

FIRE RATING

WALL CODE TYPE

NAME: IW\_02\_1 (2GB\_4\_1GB) Corridor  
COMMENT: INT WD  
ASSEMBLY: IBC 722.6 (2018)  
DESCRIPTION: TYPICAL 2x4 CORRIDOR WALL 1-HR RATED



WALL PLACEMENT & DESCRIPTION

WALL TYPE

TAG: IW 02 FP 1

FIRE RATING

WALL CODE TYPE

NAME: IW\_02\_1 (1GB\_RS\_6\_1GB) Corridor  
COMMENT: INT WD  
ASSEMBLY: WP 3242  
DESCRIPTION: TYPICAL 2x6 CORRIDOR WALL 1-HR RATED W/ RESILIENT CHANNEL - 54 STC



WALL PLACEMENT & DESCRIPTION

WALL TYPE

TAG: IW 02 FP 1

FIRE RATING

WALL CODE TYPE

NAME: IW\_02\_1 (2GB\_6\_1GB) Corridor  
COMMENT: INT WD  
ASSEMBLY: IBC 722.6 (2018)  
DESCRIPTION: TYPICAL 2x6 CORRIDOR WALL 1-HR RATED



WALL PLACEMENT & DESCRIPTION

WALL TYPE

TAG: IW 02 FP 1

FIRE RATING

WALL CODE TYPE

NAME: IW\_02\_1 (1GB\_RS\_8\_1GB) Corridor  
COMMENT: INT WD  
ASSEMBLY: WP 3242  
DESCRIPTION: TYPICAL 2x8 CORRIDOR WALL 1-HR RATED W/ RESILIENT CHANNEL - 54 STC



WALL PLACEMENT & DESCRIPTION

WALL TYPE

TAG: IW 02 FP 1

FIRE RATING

WALL CODE TYPE

NAME: IW\_02\_1 (2GB\_8\_1GB) Corridor  
COMMENT: INT WD  
ASSEMBLY: IBC 722.6 (2018)  
DESCRIPTION: TYPICAL 2x8 CORRIDOR WALL 1-HR RATED



WALL PLACEMENT & DESCRIPTION

WALL TYPE

TAG: IW 02 FP 1

FIRE RATING

WALL CODE TYPE

NAME: IW\_02\_1 (2GB\_ALT\_1GB) Corridor  
COMMENT: INT WD  
ASSEMBLY: IBC 722.6 (2018)  
DESCRIPTION: ALTERNATING STUDS @ CORRIDOR WALL 1-HR RATED



**ORB ASSEMBLIES**  
CORRIDOR WOOD WALLS

**07-IW02**

DATE:  
03/01/23

2/5/2024 5:15:08 PM  
Autodesk Docs: //00-000 Revit\_Detail\_Library/4\_ORB\_Assemblies\_Split\_Walls\_2023.rvt

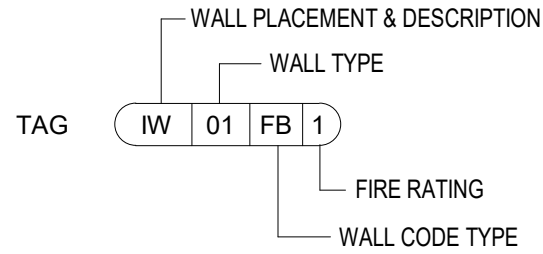

NAME: IW\_01\_1 (1GB\_4\_NA) Unit Separation  
 COMMENT: INT WD  
 ASSEMBLY: WP 5512  
 DESCRIPTION: TYPICAL 2x4 UNIT SEPARATION  
 WALL 1-HR RATED

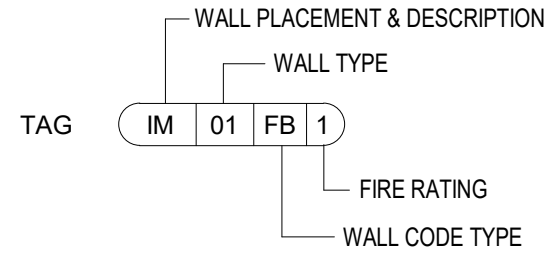

NAME: IM\_01\_1 (1GB\_4\_NA) Unit Separation  
 COMMENT: INT MTL  
 ASSEMBLY: UL U493  
 DESCRIPTION: TYPICAL 3-5/8" UNIT SEPARATION  
 WALL 1-HR RATED

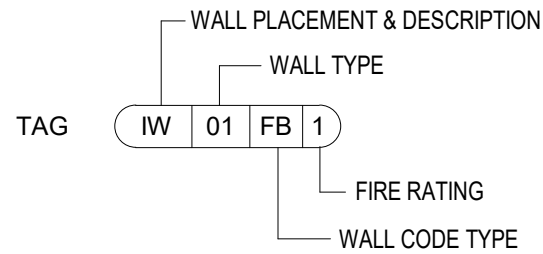

NAME: IW\_01\_1 (1GB\_6\_NA) Unit Separation  
 COMMENT: INT WD  
 ASSEMBLY: WP 5512  
 DESCRIPTION: TYPICAL 2x6 UNIT SEPARATION  
 WALL 1-HR RATED

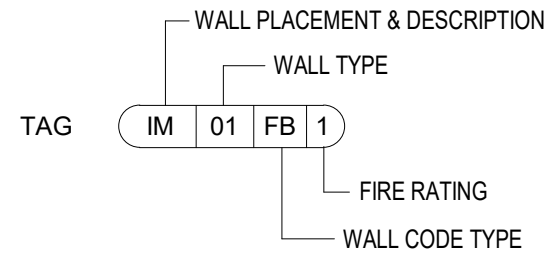

NAME: IM\_01\_1 (1GB\_6\_NA) Unit Separation  
 COMMENT: INT MTL  
 ASSEMBLY: UL U493  
 DESCRIPTION: TYPICAL 6" UNIT SEPARATION  
 WALL 1-HR RATED

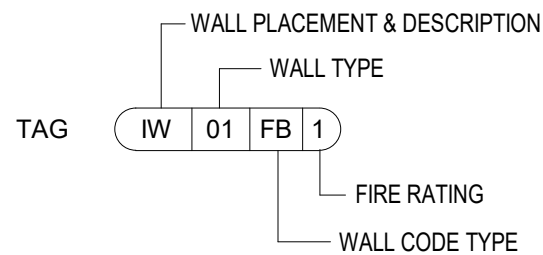

NAME: IW\_01\_1 (1GB\_8\_NA) Unit Separation  
 COMMENT: INT WD  
 ASSEMBLY: WP 5512  
 DESCRIPTION: TYPICAL 2x8 UNIT SEPARATION  
 WALL 1-HR RATED

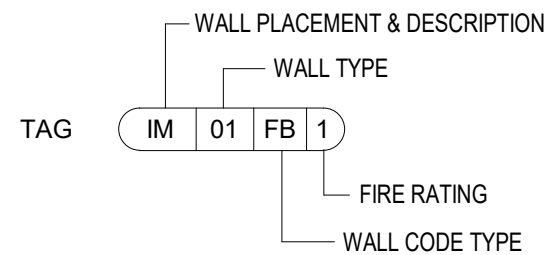

NAME: IM\_01\_1 (1GB\_8\_NA) Unit Separation  
 COMMENT: INT MTL  
 ASSEMBLY: UL U493  
 DESCRIPTION: TYPICAL 8" UNIT SEPARATION  
 WALL 1-HR RATED

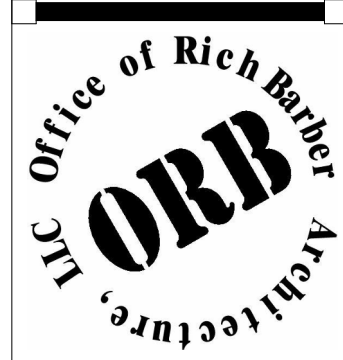

**ORB ASSEMBLIES**  
 INTERIOR WOOD FRAMED WALLS

**07-IW/IM-01**

DATE:  
03/01/23

2/5/2024 5:15:08 PM  
Autodesk Docs: //00-000-Revit-Detail-Library/4\_ORB-Assemblies-Split-Walls\_2023.rvt

**RESILIENT CHANNEL W/ 1 LAYER OF GYPSUM BOARD**



WALL PLACEMENT & DESCRIPTION

WALL TYPE

TAG IM 02 FB 1

FIRE RATING

WALL CODE TYPE

NAME: IM\_02\_1 (1GB\_RS\_4\_1GB) Corridor  
COMMENT: INT MTL  
ASSEMBLY: UL 419  
DESCRIPTION: TYPICAL 3 5/8" CORRIDOR WALL 1-HR RATED W/ RESILIENT CHANNEL - NON LOAD BEARING

**RESILIENT CHANNEL W/ NO GYP ON INTERIOR SIDE**



WALL PLACEMENT & DESCRIPTION

WALL TYPE

TAG IM 02 FB 1

FIRE RATING

WALL CODE TYPE

NAME: IM\_02\_1 (1GB\_RS\_4\_NA) Corridor  
COMMENT: INT MTL  
ASSEMBLY: UL 419  
DESCRIPTION: TYPICAL 3 5/8" CORRIDOR WALL 1-HR RATED W/ RESILIENT CHANNEL - NON LOAD BEARING

**(2) LAYERS OF GYPSUM BOARD ON EXTERIOR SIDE AND (1) LAYER ON INTERIOR SIDE**



WALL PLACEMENT & DESCRIPTION

WALL TYPE

TAG IM 02 FB 1

FIRE RATING

WALL CODE TYPE

NAME: IM\_02\_1 (2GB\_4\_1GB) Corridor  
COMMENT: INT MTL  
ASSEMBLY: WP 1052  
DESCRIPTION: TYPICAL 3-5/8" CORRIDOR WALL 1-HR RATED

**(2) LAYERS OF GYPSUM BOARD ON EXTERIOR SIDE AND NO GYPSUM ON INTERIOR SIDE**



WALL PLACEMENT & DESCRIPTION

WALL TYPE

TAG IM 02 FB 1

FIRE RATING

WALL CODE TYPE

NAME: IM\_02\_1 (2GB\_4\_NA) Corridor  
COMMENT: INT MTL  
ASSEMBLY: WP 1052  
DESCRIPTION: TYPICAL 3-5/8" CORRIDOR WALL NO-GYP INSIDE 1-HR RATED



WALL PLACEMENT & DESCRIPTION

WALL TYPE

TAG IM 02 FB 1

FIRE RATING

WALL CODE TYPE

NAME: IM\_02\_1 (1GB\_RS\_6\_1GB) Corridor  
COMMENT: INT WD  
ASSEMBLY: UL 419  
DESCRIPTION: TYPICAL 6" METAL STUD CORRIDOR WALL 1-HR RATED W/ RESILIENT CHANNEL - NON LOAD BEARING



WALL PLACEMENT & DESCRIPTION

WALL TYPE

TAG IM 02 FB 1

FIRE RATING

WALL CODE TYPE

NAME: IM\_02\_1 (1GB\_RS\_6\_NA) Corridor  
COMMENT: INT WD  
ASSEMBLY: UL 419  
DESCRIPTION: TYPICAL 6" METAL STUD CORRIDOR WALL 1-HR RATED W/ RESILIENT CHANNEL - NON LOAD BEARING



WALL PLACEMENT & DESCRIPTION

WALL TYPE

TAG IM 02 FB 1

FIRE RATING

WALL CODE TYPE

NAME: IM\_02\_1 (2GB\_6\_1GB) Corridor  
COMMENT: INT MTL  
ASSEMBLY: WP 1052  
DESCRIPTION: TYPICAL 6" CORRIDOR WALL 1-HR RATED

Empty space for assembly details.



WALL PLACEMENT & DESCRIPTION

WALL TYPE

TAG IM 02 FB 1

FIRE RATING

WALL CODE TYPE

NAME: IM\_02\_1 (1GB\_RS\_8\_1GB) Corridor  
COMMENT: INT WD  
ASSEMBLY: UL 419  
DESCRIPTION: TYPICAL 8" METAL STUD CORRIDOR WALL 1-HR RATED W/ RESILIENT CHANNEL - NON LOAD BEARING



WALL PLACEMENT & DESCRIPTION

WALL TYPE

TAG IM 02 FB 1

FIRE RATING

WALL CODE TYPE

NAME: IM\_02\_1 (1GB\_RS\_8\_NA) Corridor  
COMMENT: INT WD  
ASSEMBLY: UL 419  
DESCRIPTION: TYPICAL 8" METAL STUD CORRIDOR WALL 1-HR RATED W/ RESILIENT CHANNEL - NON LOAD BEARING



WALL PLACEMENT & DESCRIPTION

WALL TYPE

TAG IM 02 FB 1

FIRE RATING

WALL CODE TYPE

NAME: IM\_02\_1 (2GB\_8\_1GB) Corridor  
COMMENT: INT MTL  
ASSEMBLY: WP 1052  
DESCRIPTION: TYPICAL 8" CORRIDOR WALL 1-HR RATED

Empty space for assembly details.



**ORB ASSEMBLIES**  
CORRIDOR METAL WALLS

**07-IW/IM-02**

DATE:  
03/01/23

Autodesk Docs: //00-000-Revit-Detail-Library/4\_ORB-Assemblies-Split-Walls\_2023.rvt 2/5/2024 5:15:09 PM



WALL PLACEMENT & DESCRIPTION

WALL TYPE

TAG: IW 03 - 0

FIRE RATING

WALL CODE TYPE

NAME: IW\_03\_0 (1GB\_4\_1GB)  
 COMMENT: INT WD  
 ASSEMBLY: N/A  
 DESCRIPTION: TYPICAL 2x4 INTERIOR WALL  
 NON-RATED



WALL PLACEMENT & DESCRIPTION

WALL TYPE

TAG: IW 03 FB 1

FIRE RATING

WALL CODE TYPE

NAME: IW\_03\_1 (1GB\_4\_1GB)  
 COMMENT: INT WD  
 ASSEMBLY: UL U305  
 DESCRIPTION: TYPICAL 2x4 INTERIOR WALL  
 1-HR RATED



WALL PLACEMENT & DESCRIPTION

WALL TYPE

TAG: IM 03 - 0

FIRE RATING

WALL CODE TYPE

NAME: IM\_03\_0 (1GB\_4\_1GB)  
 COMMENT: INT MTL  
 ASSEMBLY: UL U423  
 DESCRIPTION: TYPICAL 3-5/8" INTERIOR WALL  
 NON-RATED



WALL PLACEMENT & DESCRIPTION

WALL TYPE

TAG: IM 03 FB 1

FIRE RATING

WALL CODE TYPE

NAME: IM\_03\_1 (1GB\_4\_1GB)  
 COMMENT: INT MTL  
 ASSEMBLY: UL U423  
 DESCRIPTION: TYPICAL 3-5/8" INTERIOR WALL  
 1-HR RATED



WALL PLACEMENT & DESCRIPTION

WALL TYPE

TAG: IW 03 - 0

FIRE RATING

WALL CODE TYPE

NAME: IW\_03\_0 (1GB\_6\_1GB)  
 COMMENT: INT WD  
 ASSEMBLY: N/A  
 DESCRIPTION: TYPICAL 2x6 INTERIOR WALL  
 NON-RATED



WALL PLACEMENT & DESCRIPTION

WALL TYPE

TAG: IW 03 FB 1

FIRE RATING

WALL CODE TYPE

NAME: IW\_03\_1 (1GB\_6\_1GB)  
 COMMENT: INT WD  
 ASSEMBLY: UL U305  
 DESCRIPTION: TYPICAL 2x6 INTERIOR WALL  
 1-HR RATED



WALL PLACEMENT & DESCRIPTION

WALL TYPE

TAG: IM 03 - 0

FIRE RATING

WALL CODE TYPE

NAME: IM\_03\_0 (1GB\_6\_1GB)  
 COMMENT: INT MTL  
 ASSEMBLY: UL U423  
 DESCRIPTION: TYPICAL 6" INTERIOR WALL  
 NON-RATED



WALL PLACEMENT & DESCRIPTION

WALL TYPE

TAG: IM 03 FB 1

FIRE RATING

WALL CODE TYPE

NAME: IM\_03\_1 (1GB\_6\_1GB)  
 COMMENT: INT MTL  
 ASSEMBLY: UL U423  
 DESCRIPTION: TYPICAL 6" INTERIOR WALL  
 1-HR RATED



WALL PLACEMENT & DESCRIPTION

WALL TYPE

TAG: IW 03 - 0

FIRE RATING

WALL CODE TYPE

NAME: IW\_03\_0 (1GB\_8\_1GB)  
 COMMENT: INT WD  
 ASSEMBLY: N/A  
 DESCRIPTION: TYPICAL 2x8 INTERIOR WALL  
 NON-RATED



WALL PLACEMENT & DESCRIPTION

WALL TYPE

TAG: IW 03 FB 1

FIRE RATING

WALL CODE TYPE

NAME: IW\_03\_1 (1GB\_8\_1GB)  
 COMMENT: INT WD  
 ASSEMBLY: UL U305  
 DESCRIPTION: TYPICAL 2x8 INTERIOR WALL  
 1-HR RATED



WALL PLACEMENT & DESCRIPTION

WALL TYPE

TAG: IM 03 - 0

FIRE RATING

WALL CODE TYPE

NAME: IM\_03\_0 (1GB\_8\_1GB)  
 COMMENT: INT MTL  
 ASSEMBLY: UL U423  
 DESCRIPTION: TYPICAL 6" INTERIOR WALL  
 NON-RATED



WALL PLACEMENT & DESCRIPTION

WALL TYPE

TAG: IM 03 FB 1

FIRE RATING

WALL CODE TYPE

NAME: IM\_03\_1 (1GB\_8\_1GB)  
 COMMENT: INT MTL  
 ASSEMBLY: UL U423  
 DESCRIPTION: TYPICAL 8" INTERIOR WALL  
 1-HR RATED



**ORB ASSEMBLIES**  
**INTERIOR WALLS**

**07-IW/IM-03**

DATE:  
 03/01/23

2/5/2024 5:15:09 PM  
Autodesk Docs: //00-000-Revit-Detail-Library/4\_ORB-Assemblies-Split-Walls\_2023.rvt



**ORB ASSEMBLIES**  
**INTERIOR WALLS**

**07-IW/IM-04/05**

DATE:  
03/01/23



WALL PLACEMENT & DESCRIPTION

WALL TYPE

TAG: IW 04 - 2

FIRE RATING

WALL CODE TYPE

NAME: IW\_04\_2 (2GB\_4\_2GB)  
COMMENT: INT WD  
ASSEMBLY: UL U301  
DESCRIPTION: TYPICAL 2x4 INTERIOR WALL 2-HR RATED



WALL PLACEMENT & DESCRIPTION

WALL TYPE

TAG: IM 04 - 2

FIRE RATING

WALL CODE TYPE

NAME: IM\_04\_2 (2GB\_4\_2GB)  
COMMENT: INT MTL  
ASSEMBLY: B2010  
DESCRIPTION: TYPICAL 3-5/8" INTERIOR WALL 2-HR RATED



WALL PLACEMENT & DESCRIPTION

WALL TYPE

TAG: IM 05 - 3

FIRE RATING

WALL CODE TYPE

NAME: IM\_05\_3 (3GB\_4\_3GB)  
COMMENT: INT MTL  
ASSEMBLY: B2010  
DESCRIPTION: TYPICAL 3-5/8" INTERIOR WALL 3-HR RATED



WALL PLACEMENT & DESCRIPTION

WALL TYPE

TAG: IM 05 - 4

FIRE RATING

WALL CODE TYPE

NAME: IM\_05\_4 (4GB\_4\_4GB)  
COMMENT: INT MTL  
ASSEMBLY: UL U419  
DESCRIPTION: TYPICAL 3-5/8" INTERIOR WALL 3-HR RATED



WALL PLACEMENT & DESCRIPTION

WALL TYPE

TAG: IW 04 - 2

FIRE RATING

WALL CODE TYPE

NAME: IW\_04\_2 (2GB\_6\_2GB)  
COMMENT: INT WD  
ASSEMBLY: UL U301  
DESCRIPTION: TYPICAL 2x6 INTERIOR WALL 2-HR RATED



WALL PLACEMENT & DESCRIPTION

WALL TYPE

TAG: IM 04 - 2

FIRE RATING

WALL CODE TYPE

NAME: IM\_04\_2 (2GB\_6\_2GB)  
COMMENT: INT MTL  
ASSEMBLY: B2010  
DESCRIPTION: TYPICAL 6" INTERIOR WALL 2-HR RATED



WALL PLACEMENT & DESCRIPTION

WALL TYPE

TAG: IM 05 - 3

FIRE RATING

WALL CODE TYPE

NAME: IM\_05\_3 (3GB\_6\_3GB)  
COMMENT: INT MTL  
ASSEMBLY: B2010  
DESCRIPTION: TYPICAL 6" INTERIOR WALL 3-HR RATED



WALL PLACEMENT & DESCRIPTION

WALL TYPE

TAG: IM 05 - 4

FIRE RATING

WALL CODE TYPE

NAME: IM\_05\_4 (4GB\_6\_4GB)  
COMMENT: INT MTL  
ASSEMBLY: UL U419  
DESCRIPTION: TYPICAL 6" INTERIOR WALL 3-HR RATED



WALL PLACEMENT & DESCRIPTION

WALL TYPE

TAG: IW 04 - 2

FIRE RATING

WALL CODE TYPE

NAME: IW\_04\_2 (2GB\_8\_2GB)  
COMMENT: INT WD  
ASSEMBLY: UL U301  
DESCRIPTION: TYPICAL 2x8 INTERIOR WALL 2-HR RATED



WALL PLACEMENT & DESCRIPTION

WALL TYPE

TAG: IM 04 - 2

FIRE RATING

WALL CODE TYPE

NAME: IM\_04\_2 (2GB\_8\_2GB)  
COMMENT: INT MTL  
ASSEMBLY: B2010  
DESCRIPTION: TYPICAL 8" INTERIOR WALL 2-HR RATED



WALL PLACEMENT & DESCRIPTION

WALL TYPE

TAG: IM 05 - 3

FIRE RATING

WALL CODE TYPE

NAME: IM\_05\_3 (3GB\_8\_3GB)  
COMMENT: INT MTL  
ASSEMBLY: B2010  
DESCRIPTION: TYPICAL 8" INTERIOR WALL 3-HR RATED



WALL PLACEMENT & DESCRIPTION

WALL TYPE

TAG: IM 05 - 4

FIRE RATING

WALL CODE TYPE

NAME: IM\_05\_4 (4GB\_8\_4GB)  
COMMENT: INT MTL  
ASSEMBLY: UL U419  
DESCRIPTION: TYPICAL 8" INTERIOR WALL 3-HR RATED



2/5/2024 5:15:10 PM  
Autodesk Docs: //00-000\_Revit\_Detail\_Library/4\_ORB\_Assemblies\_Split\_Walls\_2023.rvt

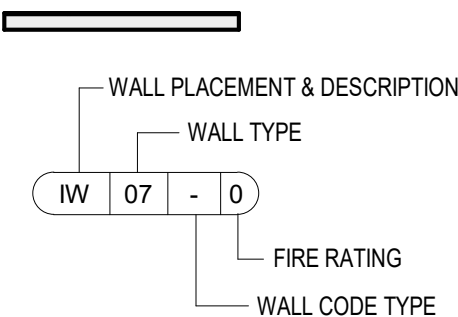

WALL PLACEMENT & DESCRIPTION

WALL TYPE

TAG: IW 07 - 0

FIRE RATING

WALL CODE TYPE

NAME: IW\_07\_0 (1GB\_4\_NA)  
COMMENT: INT WD  
ASSEMBLY: N/A  
DESCRIPTION: TYPICAL 2x4 INTERIOR WALL  
NO-GYP INSIDE NON-RATED

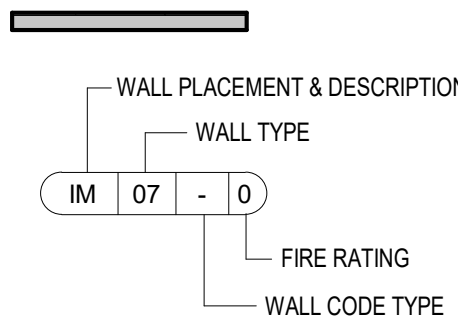

WALL PLACEMENT & DESCRIPTION

WALL TYPE

TAG: IM 07 - 0

FIRE RATING

WALL CODE TYPE

NAME: IM\_07\_0 (1GB\_4\_NA)  
COMMENT: INT MTL  
ASSEMBLY: IBC 803.15.2 (2018)  
DESCRIPTION: TYPICAL 3-5/8" INTERIOR WALL  
NO-GYP INSIDE NON-RATED

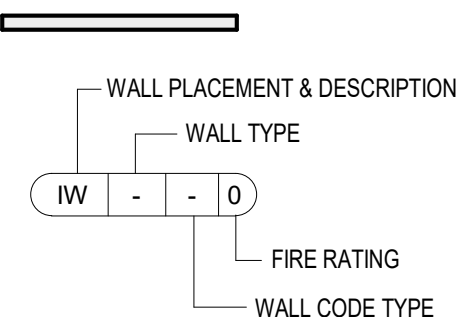

WALL PLACEMENT & DESCRIPTION

WALL TYPE

TAG: IW - - 0

FIRE RATING

WALL CODE TYPE

NAME: IW\_08\_0 (NA\_4\_NA)  
COMMENT: INT WD  
ASSEMBLY: N/A  
DESCRIPTION: 2x4 STUD ONLY WALL  
NON-RATED MODELING WALL

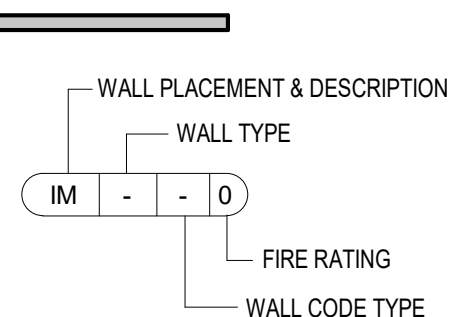

WALL PLACEMENT & DESCRIPTION

WALL TYPE

TAG: IM - - 0

FIRE RATING

WALL CODE TYPE

NAME: IM\_08\_0 (NA\_4\_NA)  
COMMENT: INT MTL  
ASSEMBLY: N/A  
DESCRIPTION: 3-5/8" STUD ONLY WALL  
NON-RATED MODELING WALL



**ORB ASSEMBLIES**  
**INTERIOR WALLS**

**07-IW/IM-07/08**

DATE:  
03/01/23

Autodesk Docs: //00-000 Revit Detail Library/4\_ORB Assemblies Split Walls\_2023.rvt 2/5/2024 5:15:10 PM



WALL PLACEMENT & DESCRIPTION

WALL TYPE

TAG: FR 01 - 0

FIRE RATING

WALL CODE TYPE

NAME: FRW\_01\_0 (1GB\_4\_NA)  
 COMMENT: FURROUT WD  
 ASSEMBLY: N/A  
 DESCRIPTION: FURROUT 2x4 FRAMING WITH 1-GYP NON-RATED



WALL PLACEMENT & DESCRIPTION

WALL TYPE

TAG: FR 02 - 0

FIRE RATING

WALL CODE TYPE

NAME: FRW\_02\_0 (2GB\_4\_NA)  
 COMMENT: FURROUT WD  
 ASSEMBLY: N/A  
 DESCRIPTION: FURROUT 2x4 FRAMING WITH 2-GYP NON-RATED



WALL PLACEMENT & DESCRIPTION

WALL TYPE

TAG: FR 01 - 0

FIRE RATING

WALL CODE TYPE

NAME: FRM\_01\_0 (1GB\_4\_NA)  
 COMMENT: FURROUT MTL  
 ASSEMBLY: N/A  
 DESCRIPTION: FURROUT 3-5/8" FRAMING WITH 1-GYP NON-RATED



WALL PLACEMENT & DESCRIPTION

WALL TYPE

TAG: FR 02 - 0

FIRE RATING

WALL CODE TYPE

NAME: FRM\_02\_0 (2GB\_4\_FLAT\_NA)  
 COMMENT: FURROUT MTL  
 ASSEMBLY: N/A  
 DESCRIPTION: FURROUT 1-3/8" FRAMING WITH 2-GYP NON-RATED



WALL PLACEMENT & DESCRIPTION

WALL TYPE

TAG: FR 01 - 0

FIRE RATING

WALL CODE TYPE

NAME: FRW\_01\_0 (1GB\_4 Flat\_NA)  
 COMMENT: FURROUT WD  
 ASSEMBLY: N/A  
 DESCRIPTION: FURROUT 2x FLAT FRAMING WITH 1-GYP NON-RATED



WALL PLACEMENT & DESCRIPTION

WALL TYPE

TAG: FR 02 - 0

FIRE RATING

WALL CODE TYPE

NAME: FRW\_02\_0 (2GB\_4 Flat\_NA)  
 COMMENT: FURROUT WD  
 ASSEMBLY: N/A  
 DESCRIPTION: FURROUT 2x FLAT FRAMING WITH 2-GYP & SHEAR TO MATCH CORRIDOR NON-RATED



WALL PLACEMENT & DESCRIPTION

WALL TYPE

TAG: FR 02 - 0

FIRE RATING

WALL CODE TYPE

NAME: FRM\_02\_0 (2GB\_4\_NA)  
 COMMENT: FURROUT MTL  
 ASSEMBLY: N/A  
 DESCRIPTION: FURROUT 3-5/8" FRAMING WITH 2-GYP NON-RATED



WALL PLACEMENT & DESCRIPTION

WALL TYPE

TAG: FR 03 - 0

FIRE RATING

WALL CODE TYPE

NAME: FRM\_03\_0 (1GB\_RC\_NA)  
 COMMENT: FURROUT MTL  
 ASSEMBLY: N/A  
 DESCRIPTION: FURROUT 1/2" RC-CHANNELS FRAMING WITH 1-GYP NON-RATED



WALL PLACEMENT & DESCRIPTION

WALL TYPE

TAG: FM 01 - 0

FIRE RATING

WALL CODE TYPE

NAME: FRM\_01\_0 (1GB\_4 FLAT\_NA)  
 COMMENT: FURROUT MTL  
 ASSEMBLY: N/A  
 DESCRIPTION: FURROUT 1-3/8" FRAMING WITH 1-GYP NON-RATED



WALL PLACEMENT & DESCRIPTION

WALL TYPE

TAG: FR 04 - 0

FIRE RATING

WALL CODE TYPE

NAME: FRM\_04\_0 (2GB\_RC\_NA)  
 COMMENT: FURROUT MTL  
 ASSEMBLY: N/A  
 DESCRIPTION: FURROUT 1/2" RC-CHANNELS FRAMING WITH 2-GYP NON-RATED



**ORB ASSEMBLIES**  
FURRING WALLS

**08-FURR**

DATE:  
03/01/23

2/5/2024 5:15:11 PM  
Autodesk Docs: //00-000 Revit Detail Library/4\_ORB Assemblies Split Walls\_2023.rvt

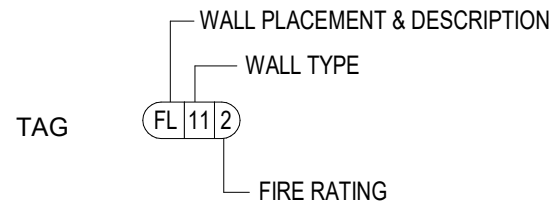
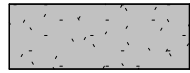

NAME: FL\_11\_2\_GARAGE CONCRETE TOPPING SLAB  
COMMENT: CONCRETE GARAGE SLAB  
ASSEMBLY: UL J704  
DESCRIPTION: TYP. GARAGE 2-HR POST-TENSION CONCRETE SLAB

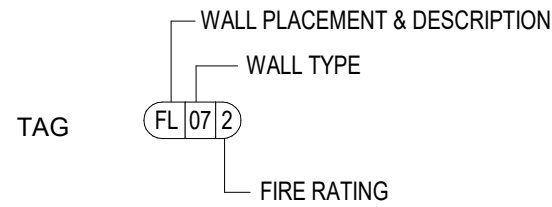
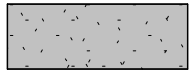

NAME: FL\_07\_2\_GARAGE CONCRETE SLAB - 8"  
COMMENT: CONCRETE GARAGE SLAB  
ASSEMBLY: IBC 2018 TABLE 721.1 (2)  
DESCRIPTION: TYP. GARAGE 2-HR POST-TENSION CONCRETE SLAB

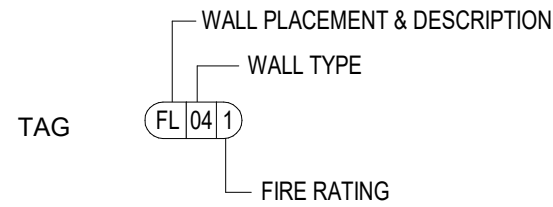

NAME: FL\_04\_1\_CORRIDOR FLOOR 2x10  
COMMENT: BUILDING CORRIDOR FLOOR  
ASSEMBLY: L512  
DESCRIPTION: TYPICAL 1-HR CORRIDOR FLOOR

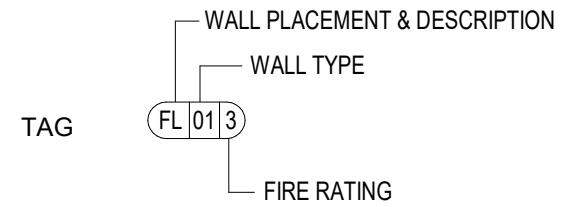
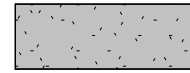

NAME: FL\_01\_3\_Podium Concrete Slab- 14"  
COMMENT: CONCRETE PODIUM SLAB  
ASSEMBLY: IBC 2018 TABLE 721.1 (3) ITEM NO 1-1.1  
DESCRIPTION: 3-HR RATED SILICEOUS AGGREGATE CONCRETE TYPICAL PODIUM SLAB

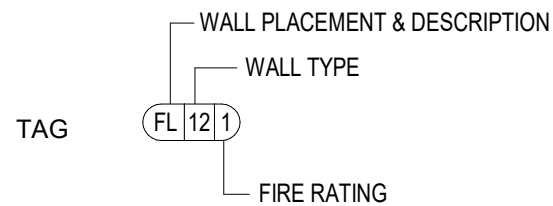
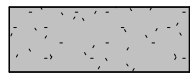

NAME: FL\_12\_1\_OPEN WEB TRUSS @ BALCONIES  
COMMENT: BALCONY FLOOR  
ASSEMBLY: UL L546  
DESCRIPTION: 1 HR FLOOR/CEILING OPEN WEB TRUSS AT BALCONIES WITH RESILIENT CLIP

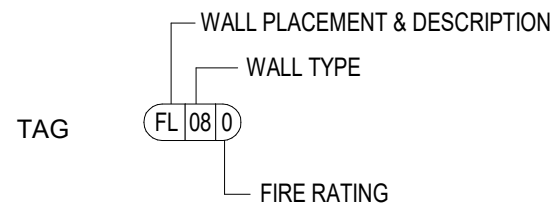
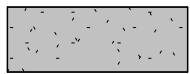

NAME: FL\_08\_0\_SLAB ON GRADE 8"  
COMMENT: CONCRETE SLAB ON GRADE  
ASSEMBLY:  
DESCRIPTION: TYP. NON RATED SLAB ON GRADE

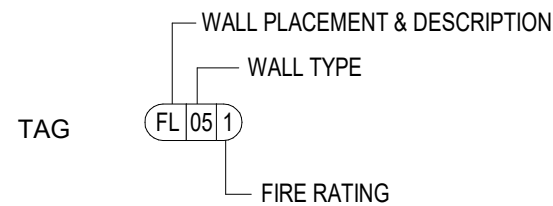

NAME: FL\_05\_1\_Balcony Floor 2x10  
COMMENT: UNIT BALCONY FLOOR  
ASSEMBLY: L512  
DESCRIPTION: TYP. 1-HR RATED BALCONY FLOOR

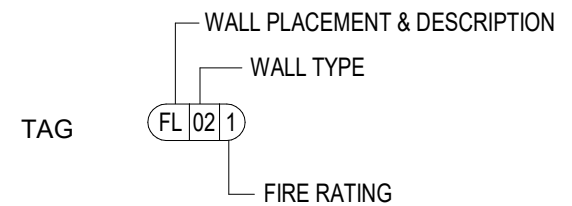
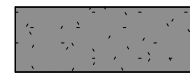

NAME: FL\_02\_1\_UNIT FLOOR TO CEILING  
COMMENT: UNIT FLOOR  
ASSEMBLY: UL L550  
DESCRIPTION: TYP. 1-HR RATED UNIT FLOOR

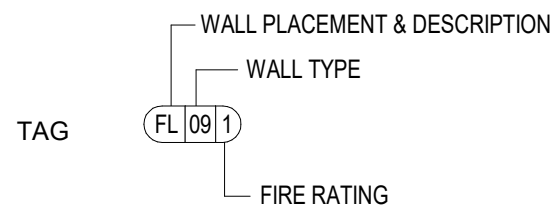

NAME: FL\_09\_1\_LW CONCRETE ON METAL DECK  
COMMENT: LIGHT WEIGHT CONCRETE ON 3 1/2" METAL DECK  
ASSEMBLY: D902  
DESCRIPTION: 1 HR UNPROTECTED DECK

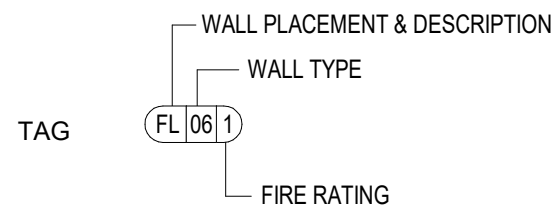

NAME: FL\_06\_1\_EXTERIOR CORRIDOR FLOOR 2x10  
COMMENT: BUILDING CORRIDOR FLOOR  
ASSEMBLY: 2012 IBC TABLE 721.1 (3). ITEM 13-1.2  
DESCRIPTION: 1-HR CORRIDOR FLOOR AT EXTERIOR SOFFIT CONDITION

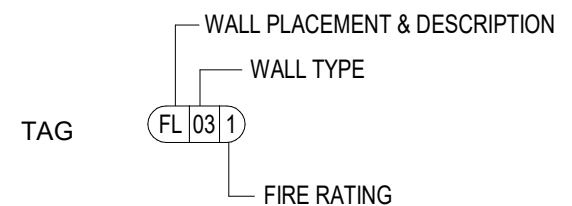
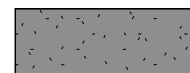

NAME: FL\_03\_1\_UNIT FLOOR TO CEILING ( TO OTHER USES)  
COMMENT: UNIT FLOOR  
ASSEMBLY: UL L574  
DESCRIPTION: 1-HR RATED UNIT FLOOR WITH ENHANCED STC RATING



**ORB ASSEMBLIES**  
FLOORS AND CONCRETE SLABS

**13-FL-1**

DATE:  
07/21/21



**ORB ASSEMBLIES**  
**ROOFS**

Diagram showing a rectangular box with a tag 'RF 05 2' connected to labels: WALL PLACEMENT & DESCRIPTION, WALL TYPE, and FIRE RATING.

NAME: RF\_05\_2 CONCRETE OVER METAL DECK  
 COMMENT: NON-RATED ROOF  
 ASSEMBLY: UL S721  
 DESCRIPTION: ROOF COVERING OVER METAL DECK

Diagram showing a rectangular box with a tag 'RF 03 1' connected to labels: WALL PLACEMENT & DESCRIPTION, WALL TYPE, and FIRE RATING.

NAME: RF\_03\_1 SOFFITS  
 COMMENT: SMALL PROJECTIONS SOFFIT  
 ASSEMBLY: 2018 IBC TABLE 721.1(3), ITEM 13-1.2  
 DESCRIPTION: 1-HR WOOD SOFFIT TPO FINISH

Diagram showing a rectangular box with a tag 'RF 01 1' connected to labels: WALL PLACEMENT & DESCRIPTION, WALL TYPE, and FIRE RATING.

NAME: RF\_01\_1 TOP CHORD  
 COMMENT: BUILDING ROOF TOP CORD OVERLAY TO 2'-0" MIN WIDTH  
 ASSEMBLY: P531  
 DESCRIPTION: TYP. 1-HR WOOD TRUSS ROOF

Diagram showing a rectangular box with a tag 'RF 05 3' connected to labels: WALL PLACEMENT & DESCRIPTION, WALL TYPE, and FIRE RATING.

NAME: RF\_05\_3 CONCRETE OVER METAL DECK  
 COMMENT: NON-RATED ROOF  
 ASSEMBLY: UL S721  
 DESCRIPTION: ROOF COVERING OVER METAL DECK

Diagram showing a rectangular box with a tag 'RF 04 0' connected to labels: WALL PLACEMENT & DESCRIPTION, WALL TYPE, and FIRE RATING.

NAME: RF\_04\_0 NON-RATED  
 COMMENT: NON-RATED ROOF  
 ASSEMBLY: N/A  
 DESCRIPTION: WOOD ROOF

Diagram showing a rectangular box with a tag 'RF 01 1' connected to labels: WALL PLACEMENT & DESCRIPTION, WALL TYPE, and FIRE RATING.

NAME: RF\_01\_1 BOTTOM CHORD  
 COMMENT: BUILDING ROOF TOP CORD UNDERLAY TO 2'-0" MIN WIDTH  
 ASSEMBLY: P531  
 DESCRIPTION: TYP. 1-HR WOOD TRUSS ROOF

Diagram showing a rectangular box with a tag 'RF 05 1' connected to labels: WALL PLACEMENT & DESCRIPTION, WALL TYPE, and FIRE RATING.

NAME: RF\_05\_1 CONCRETE OVER METAL DECK  
 COMMENT: CONCRETE OVER METAL DECK ROOF  
 ASSEMBLY: UL S721  
 DESCRIPTION: ROOF COVERING OVER METAL DECK

Diagram showing a rectangular box with a tag 'RF 02 1' connected to labels: WALL PLACEMENT & DESCRIPTION, WALL TYPE, and FIRE RATING.

NAME: RF\_02\_1 BALCONY/STAIR/ELEVATOR ROOF  
 COMMENT: ROOF OVER BALCONY/STAIRS/ELEVATORS  
 ASSEMBLY: RC 2601 GA-600-2018  
 DESCRIPTION: TYP. 1-HR BALCONY ROOF GYP. FINISH

**14-RF-1**  
DATE: 08/10/21



**ORB ASSEMBLIES**  
**CEILING - NON RATED**

**15-CLG**

DATE:  
03/01/23

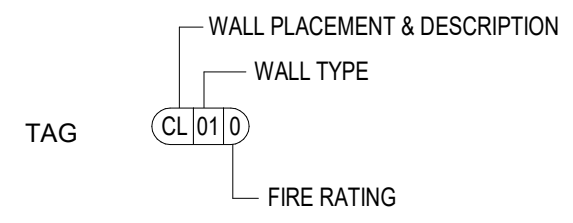
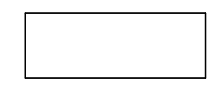

NAME: CL\_01\_0 SUSPENDED CEILING  
COMMENT: FURR DOWN CEILING, NOT PART OF ASSEMBLY  
ASSEMBLY: C3030220  
DESCRIPTION: GYPSUM WALL BOARD OVER 3 5/8" METAL STUDS

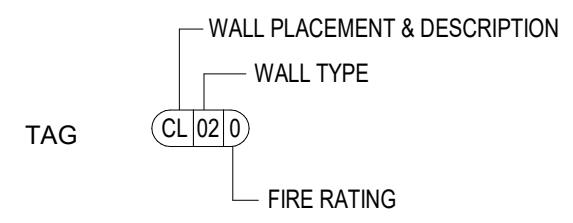
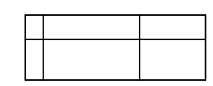

NAME: CL\_02\_0 2'x2' SUSPENDED TILE CEILING  
COMMENT: SUSPENDED ACOUSTICAL CEILING TILES  
ASSEMBLY: C3030210  
DESCRIPTION: 24"x24" 3/4" CEILING TILES IN 15/16" CEILING GRID

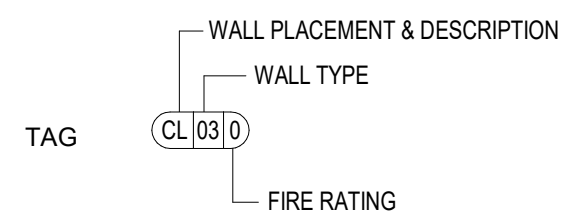
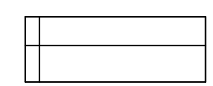

NAME: CL\_03\_0 2'x4' SUSPENDED TILE CEILING  
COMMENT: SUSPENDED ACOUSTICAL CEILING TILES  
ASSEMBLY: C3030210  
DESCRIPTION: 24"x24" 3/4" CEILING TILES IN 15/16" CEILING GRID